

作業範囲図

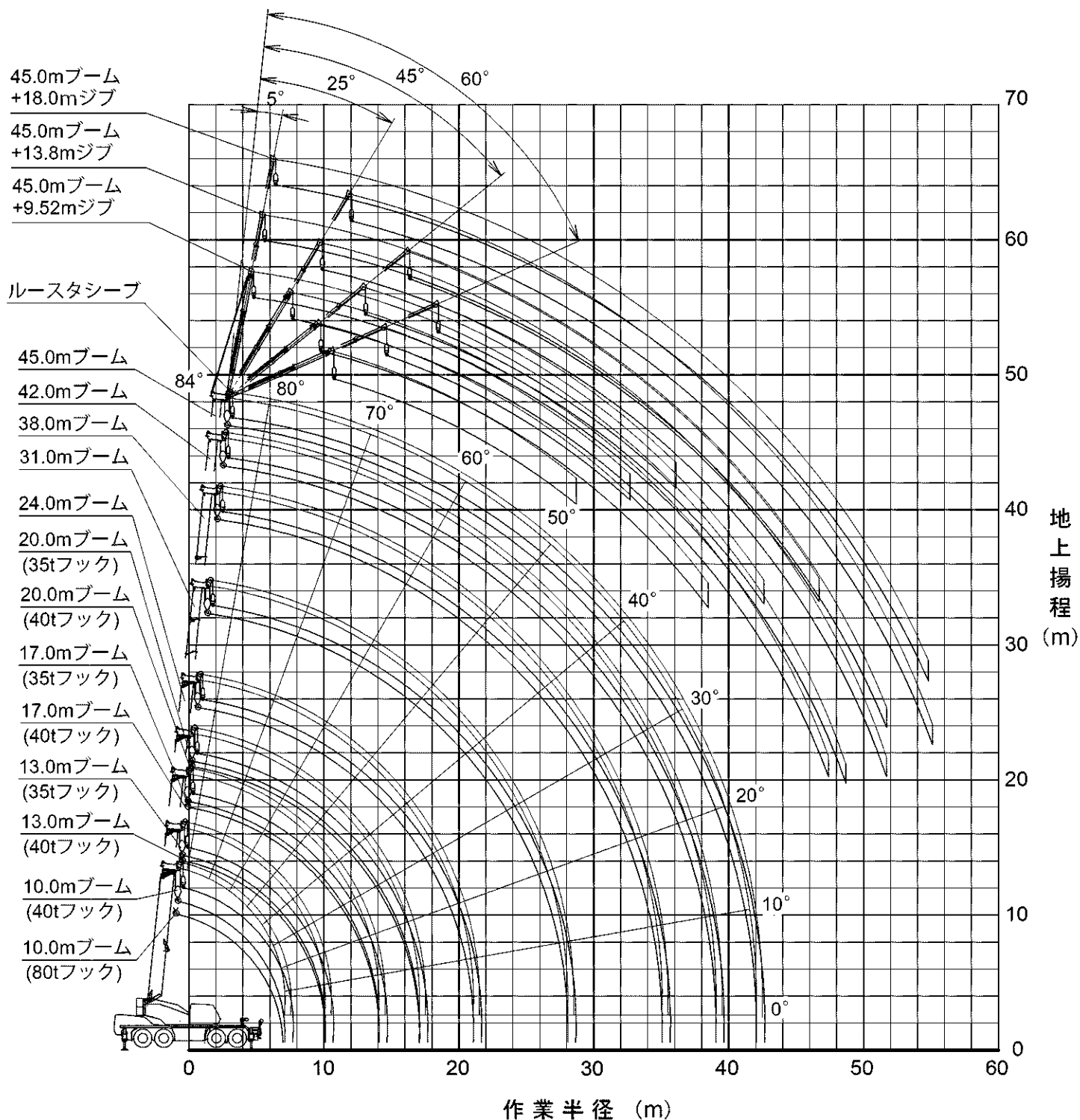

- (注意) 1. 本図はブーム・ジブのたわみを含んでいません。
 2. 本図はカウンタウエイト付、アウトリガ張出(前方)のものです。

■ 全体図

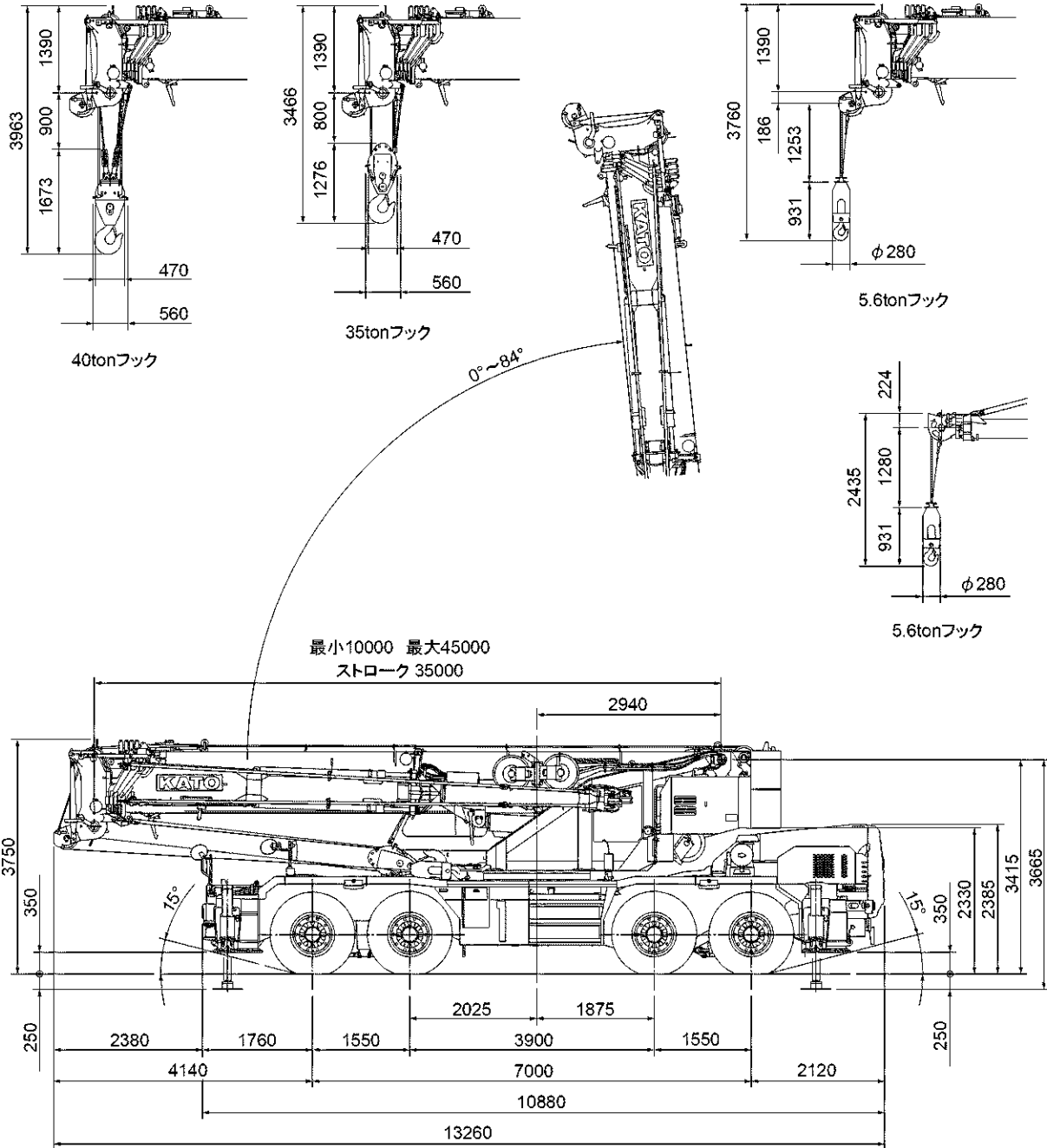

ランブブレークオーバーアングル: 30°
 サスペンションロック時全高より: -85mm
 (サスペンションシリンダー最縮小)



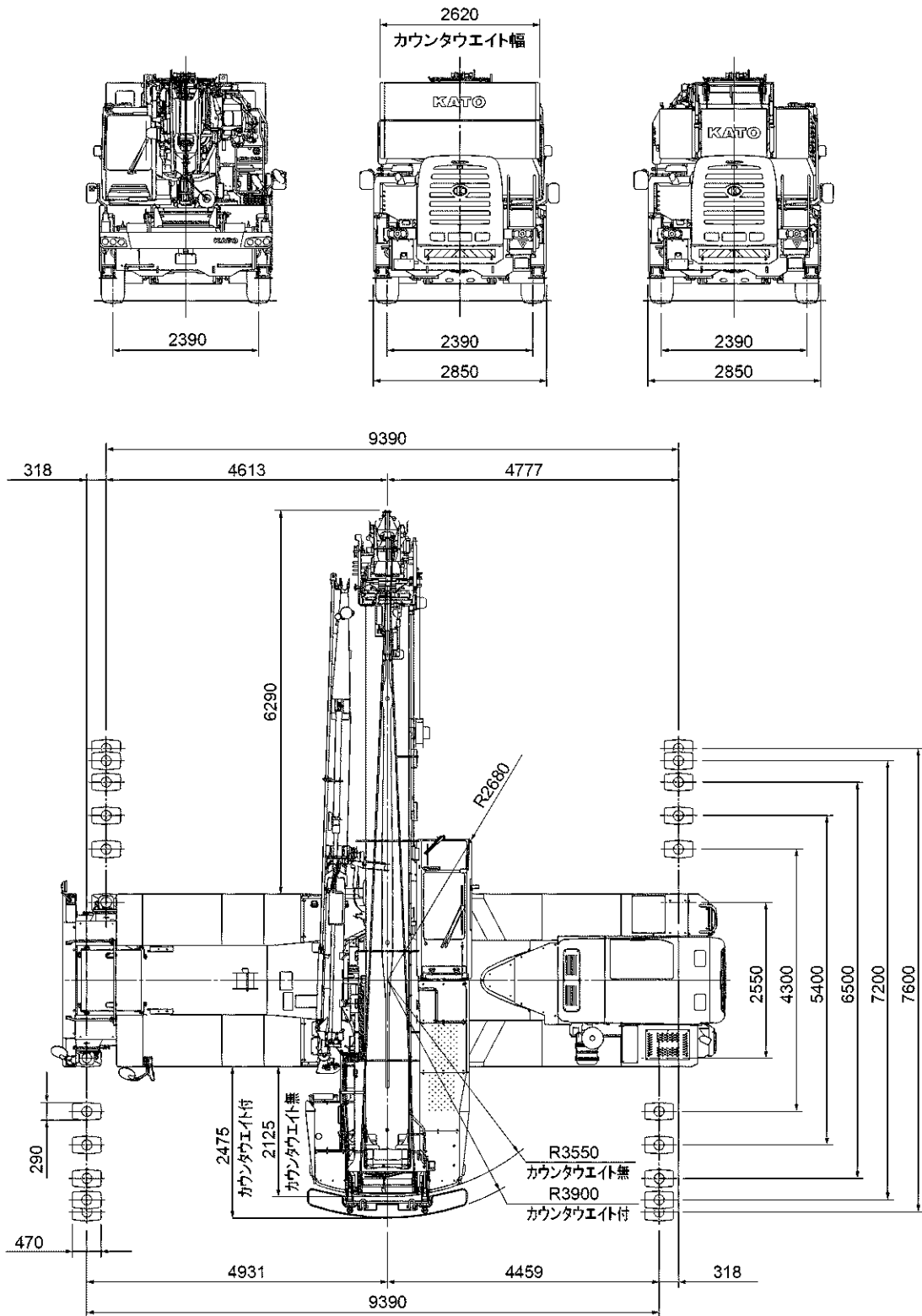

縮尺: $\frac{1}{100}$ 単位 (mm)

■ 全体図



縮尺: $\frac{1}{100}$ 単位 (mm)

ブーム (CW無) 定格総荷重表

	ブーム (CW無)..... 85
	24mブーム+SLジブ (CW無)..... 91
	45mブーム+SLジブ (CW無)..... 107
	ブーム【特殊伸縮】(CW無)..... 119
	31m特殊伸縮ブーム+SLジブ (CW無)..... 129





KATO SL-850RfII ブーム定格総荷重表

通常伸縮 カウンタウエイト無	ブーム	ジブ	アウトリガ 前方	作業範囲
-------------------	-----	----	-------------	------

[m]	10.0	13.0	17.0	20.0	24.0	31.0	38.0	42.0	45.0
2.3	75.00*	40.00*	40.00*	38.00*	35.00				
2.5	71.00*	40.00*	40.00*	38.00*	35.00	14.00			
3.0	63.00*	40.00*	40.00*	38.00*	35.00	14.00			
3.5	57.50*	40.00*	40.00*	38.00*	35.00	14.00	13.00		
4.0	52.00*	40.00*	40.00*	37.00*	32.50	14.00	13.00	10.20	
4.5	48.00*	40.00*	40.00*	34.00	30.30	14.00	13.00	10.20	8.20
5.0	43.00*	40.00*	39.00*	32.00	28.30	14.00	13.00	10.20	8.20
5.5	39.00	38.60*	37.00*	30.00	26.50	14.00	13.00	10.20	8.20
6.0	35.50	35.15*	35.00	28.50	24.90	14.00	13.00	10.20	8.20
6.5	32.50	32.20	32.10	27.00	23.50	14.00	13.00	10.20	8.20
7.0		29.70	29.60	25.50	22.20	14.00	13.00	10.20	8.20
8.0		25.50	25.40	23.00	19.90	14.00	13.00	10.20	8.20
9.0		22.15	22.15	21.00	18.10	14.00	13.00	10.20	8.20
10.0			19.50	19.00	16.50	14.00	12.70	10.20	8.20
11.0			17.35	17.30	15.10	13.10	12.10	10.20	8.20
12.0			14.85	14.45	13.90	12.10	11.10	10.20	8.20
13.0			12.60	12.50	12.45	11.10	10.20	9.55	8.20
14.0				11.10	11.00	10.30	9.50	8.95	8.10
15.0				9.90	9.80	9.60	8.80	8.45	7.70
16.0				8.60	8.50	9.00	8.20	7.95	7.20
17.0					7.50	8.10	7.60	7.45	6.75
18.0					6.50	7.15	6.90	6.85	6.30
19.0					5.70	6.50	6.50	6.35	5.90
20.0					4.95	5.90	6.10	5.85	5.50
21.0						5.30	5.70	5.40	5.20
22.0						4.80	5.20	5.10	4.90
23.0						4.25	4.75	4.75	4.55
24.0						3.85	4.40	4.50	4.30
26.0						2.95	3.60	3.70	3.90
28.0						2.20	2.90	3.10	3.25
30.0							2.30	2.60	2.65
32.0							1.80	2.10	2.15
33.0							1.60	1.85	1.95
34.0							1.40	1.65	1.75
36.0								1.25	1.35
38.0								0.95	1.05
40.0									0.80
41.0									0.65
危険 角度	[°]	-	-	-	-	-	-	-	-
標準 フック	[ton]	80*/40	40*/35			35			
フック 質量	[kg]	830*/470	470*/330			330			
巻掛 本数	[本]	20*/10	10*/7			7	4		

(単位 : ton)

通常伸縮 カウンタウエイト無	ブーム	ジブ	アウトリガ 7.6m	作業範囲
-------------------	-----	----	---------------	------

[m]		10.0	13.0	17.0	20.0	24.0	31.0	38.0	42.0	45.0
 [m]	2.3	75.00*	40.00*	40.00*	38.00*	35.00				
	2.5	71.00*	40.00*	40.00*	38.00*	35.00	14.00			
	3.0	63.00*	40.00*	40.00*	38.00*	35.00	14.00			
	3.5	57.50*	40.00*	40.00*	38.00*	35.00	14.00	13.00		
	4.0	52.00*	40.00*	40.00*	37.00*	32.50	14.00	13.00	10.20	
	4.5	48.00*	40.00*	40.00*	34.00	30.30	14.00	13.00	10.20	8.20
	5.0	43.00*	40.00*	39.00*	32.00	28.30	14.00	13.00	10.20	8.20
	5.5	39.00	38.60*	37.00*	30.00	26.50	14.00	13.00	10.20	8.20
	6.0	35.50	35.15*	35.00	28.50	24.90	14.00	13.00	10.20	8.20
	6.5	32.50	32.20	32.10	27.00	23.50	14.00	13.00	10.20	8.20
	7.0		29.70	29.60	25.50	22.20	14.00	13.00	10.20	8.20
	8.0		23.70	23.60	23.00	19.90	14.00	13.00	10.20	8.20
	9.0		18.30	18.25	18.20	18.10	14.00	13.00	10.20	8.20
	10.0			14.65	14.55	14.50	14.00	12.70	10.20	8.20
	11.0			12.05	11.95	11.90	13.05	12.10	10.20	8.20
	12.0			10.05	9.95	9.90	11.00	11.10	10.20	8.20
	13.0			8.50	8.40	8.35	9.40	10.20	9.55	8.20
	14.0				7.15	7.00	8.10	8.60	8.95	8.10
	15.0				6.15	5.95	7.00	7.55	7.80	7.70
	16.0				5.20	5.05	6.05	6.65	6.85	7.20
	17.0					4.25	5.30	5.85	6.05	6.20
	18.0					3.60	4.60	5.15	5.35	5.50
	19.0					3.05	4.00	4.55	4.75	4.90
	20.0					2.60	3.50	4.00	4.20	4.35
	21.0						3.05	3.55	3.75	3.90
	22.0						2.65	3.15	3.35	3.45
	23.0						2.30	2.75	3.00	3.10
	24.0						1.95	2.45	2.65	2.75
	26.0						1.35	1.85	2.10	2.20
	28.0						0.85	1.35	1.60	1.70
	30.0							0.95	1.15	1.30
	32.0							0.55	0.80	0.95
	33.0								0.65	0.80
	34.0									0.65
 危険角度 [°]		—	—	—	—	—	—	19	28	33
 標準フック [ton]		80*/40	40*/35			35				
 フック質量 [kg]		830*/470	470*/330			330				
 巻掛本数 [本]		20*/10	10*/7			7	4			



(単位 : ton)







KATO SL-850RfII ブーム定格総荷重表

通常伸縮 カウンタウエイト無	ブーム	ジブ	アウトリガ 7.2m	作業範囲
-------------------	-----	----	---------------	------



[m]	10.0	13.0	17.0	20.0	24.0	31.0	38.0	42.0	45.0	
2.3	55.00*	40.00*	40.00*	38.00*	35.00					
2.5	55.00*	40.00*	40.00*	38.00*	35.00	14.00				
3.0	55.00*	40.00*	40.00*	38.00*	35.00	14.00				
3.5	50.00*	40.00*	40.00*	38.00*	35.00	14.00	13.00			
4.0	45.40*	40.00*	40.00*	37.00*	32.50	14.00	13.00	10.20		
4.5	41.40*	40.00*	40.00*	34.00	30.30	14.00	13.00	10.20	8.20	
5.0	37.90	37.80*	37.80*	32.00	28.30	14.00	13.00	10.20	8.20	
5.5	34.90	34.80	34.80	30.00	26.50	14.00	13.00	10.20	8.20	
6.0	32.30	32.20	32.10	28.50	24.90	14.00	13.00	10.20	8.20	
6.5	30.00	29.90	29.80	27.00	23.50	14.00	13.00	10.20	8.20	
7.0		28.50	27.70	25.00	22.20	14.00	13.00	10.20	8.20	
8.0		21.15	20.85	20.70	19.90	14.00	13.00	10.20	8.20	
9.0		16.50	16.25	16.10	16.10	14.00	13.00	10.20	8.20	
10.0			13.05	12.90	12.90	14.00	12.70	10.20	8.20	
11.0			10.70	10.60	10.55	11.70	12.10	10.20	8.20	
12.0			8.95	8.80	8.75	9.85	10.35	10.20	8.20	
13.0			7.55	7.40	7.35	8.40	8.95	9.05	8.20	
14.0				6.30	6.25	7.20	7.75	7.95	8.10	
15.0				5.35	5.30	6.25	6.75	7.00	7.10	
16.0				4.55	4.45	5.45	5.95	6.15	6.25	
17.0					3.70	4.75	5.25	5.45	5.55	
18.0					3.10	4.10	4.65	4.85	4.95	
19.0					2.50	3.55	4.10	4.30	4.40	
20.0					2.00	3.05	3.55	3.80	3.95	
21.0						2.60	3.15	3.35	3.45	
22.0						2.20	2.75	2.95	3.10	
23.0						1.85	2.40	2.60	2.75	
24.0						1.50	2.05	2.30	2.40	
26.0						0.95	1.55	1.75	1.85	
28.0							1.05	1.30	1.40	
30.0							0.65	0.85	1.00	
32.0									0.65	
危険 角度	[°]	-	-	-	-	-	-	26	33	37
標準 フック	[ton]	80*/40	40*/35			35				
フック 質量	[kg]	830*/470	470*/330			330				
巻掛 本数	[本]	20*/10	10*/7			7	4			





(単位 : ton)

通常伸縮 カウンタウエイト無	ブーム 	ジブ	アウトリガ  6.5m	作業範囲 
-------------------	---	----	---	--

 [m]		10.0	13.0	17.0	20.0	24.0	31.0	38.0	42.0	45.0
 [m]	2.3	50.00*	40.00*	40.00*	38.00*	35.00				
	2.5	50.00*	40.00*	40.00*	38.00*	35.00	14.00			
	3.0	50.00*	40.00*	40.00*	38.00*	35.00	14.00			
	3.5	48.00*	40.00*	40.00*	38.00*	35.00	14.00	13.00		
	4.0	43.50*	40.00*	40.00*	37.00*	32.50	14.00	13.00	10.20	
	4.5	39.60	39.50*	39.40*	34.00	30.30	14.00	13.00	10.20	8.20
	5.0	36.20	36.10*	36.00*	32.00	28.30	14.00	13.00	10.20	8.20
	5.5	33.30	33.15	33.00	30.00	26.50	14.00	13.00	10.20	8.20
	6.0	30.70	30.60	30.50	28.00	24.90	14.00	13.00	10.20	8.20
	6.5	26.90	26.75	26.60	25.90	23.50	14.00	13.00	10.20	8.20
	7.0		22.85	22.55	22.40	21.30	14.00	13.00	10.20	8.20
	8.0		17.20	17.00	16.80	16.85	14.00	13.00	10.20	8.20
	9.0		13.50	13.30	13.15	13.15	14.00	13.00	10.20	8.20
	10.0			10.70	10.55	10.55	11.70	11.70	10.20	8.20
	11.0			8.80	8.65	8.65	9.70	10.05	10.00	8.20
	12.0			7.30	7.15	7.15	8.15	8.70	8.70	8.20
	13.0			6.10	6.00	5.95	6.95	7.45	7.60	7.60
	14.0				5.00	5.00	5.95	6.45	6.65	6.70
	15.0				4.20	4.15	5.10	5.60	5.80	5.95
	16.0				3.45	3.45	4.40	4.90	5.10	5.20
17.0					2.75	3.80	4.30	4.50	4.60	
18.0					2.15	3.25	3.75	3.95	4.10	
19.0					1.65	2.75	3.25	3.45	3.60	
20.0					1.20	2.25	2.80	3.00	3.15	
21.0						1.95	2.45	2.65	2.75	
22.0						1.50	2.10	2.30	2.40	
23.0						1.15	1.75	2.00	2.15	
24.0						0.85	1.45	1.70	1.85	
26.0							0.90	1.10	1.35	
28.0								0.70	0.85	
 危険 角度	[°]	—	—	—	—	—	21	35	41	45
 標準 フック	[ton]	80*/40	40*/35			35				
 フック 質量	[kg]	830*/470	470*/330			330				
 巻掛 本数	[本]	20*/10	10*/7			7	4			

(単位 : ton)

通常伸縮 カウンタウエイト無	ブーム 	ジブ	アウトリガ  5.4m	作業範囲 
-------------------	--	----	--	---

 [m]	10.0	13.0	17.0	20.0	24.0	31.0	38.0	42.0	45.0	
2.3	50.00*	40.00*	40.00*	38.00*	35.00					
2.5	50.00*	40.00*	40.00*	38.00*	35.00	14.00				
3.0	49.80*	40.00*	40.00*	38.00*	35.00	14.00				
3.5	44.50*	40.00*	40.00*	38.00*	35.00	14.00	13.00			
4.0	40.00	40.00*	40.00*	37.00*	32.50	14.00	13.00	10.20		
4.5	36.20	36.10*	36.00*	34.00	30.30	14.00	13.00	10.20	8.20	
5.0	33.00	32.95	31.20	29.05	26.80	14.00	13.00	10.20	8.20	
5.5	26.55	26.45	26.15	24.55	22.85	14.00	13.00	10.20	8.20	
6.0	22.00	21.90	21.60	21.10	19.70	14.00	13.00	10.20	8.20	
6.5	18.65	18.50	18.25	18.10	17.20	14.00	13.00	10.20	8.20	
7.0		15.90	15.65	15.50	15.15	14.00	13.00	10.20	8.20	
8.0		12.15	11.95	11.80	11.80	12.40	12.20	10.20	8.20	
9.0		9.60	9.40	9.25	9.25	10.20	10.20	10.10	8.20	
10.0			7.50	7.40	7.40	8.40	8.60	8.60	8.20	
11.0			6.10	6.00	6.00	6.95	7.35	7.35	7.35	
12.0			5.00	4.90	4.85	5.80	6.30	6.35	6.35	
13.0			4.10	4.00	3.95	4.90	5.35	5.50	5.50	
14.0				3.30	3.20	4.10	4.50	4.75	4.80	
15.0				2.60	2.50	3.45	3.95	4.15	4.20	
16.0				2.00	1.85	2.90	3.40	3.60	3.65	
17.0					1.30	2.40	2.90	3.10	3.20	
18.0					0.80	1.90	2.45	2.65	2.80	
19.0						1.45	2.05	2.25	2.40	
20.0						1.05	1.65	1.90	2.05	
21.0						0.75	1.30	1.55	1.70	
22.0							1.00	1.25	1.40	
23.0								0.70	0.85	
 危険 角度 標準 フック	[°]	—	—	—	—	24	37	48	53	55
 フック 質量	[kg]	830*/470	470*/330			330				
 巻掛 本数	[本]	20*/10	10*/7			7	4			

(単位 : ton)



SL-850RfII ブーム定格総荷重表

通常伸縮 カウンタウイト無	ブーム	ジブ	アウトリガ 4.3m	作業範囲
------------------	-----	----	---------------	------

[m]		10.0	13.0	17.0	20.0	24.0	31.0	38.0	42.0	45.0
[m]	2.3	40.00*	40.00*	40.00*	38.00*	35.00				
	2.5	40.00*	40.00*	40.00*	38.00*	35.00	14.00			
	3.0	40.00*	40.00*	40.00*	38.00*	35.00	14.00			
	3.5	40.00*	40.00*	37.90*	34.60	31.20	14.00	13.00		
	4.0	32.00	31.00	30.05	27.70	25.35	14.00	13.00	10.20	
	4.5	25.70	25.00	24.60	22.85	20.15	14.00	13.00	10.20	8.20
	5.0	20.60	20.45	20.30	19.20	17.85	14.00	13.00	10.20	8.20
	5.5	17.00	16.85	16.70	16.40	15.30	14.00	13.00	10.20	8.20
	6.0	14.40	14.20	14.00	14.00	13.25	13.35	12.95	10.20	8.20
	6.5	12.30	12.10	11.90	11.90	11.55	11.85	11.60	10.20	8.20
	7.0		10.30	10.30	10.25	10.20	10.55	10.40	10.20	8.20
	8.0		7.90	7.80	7.80	7.70	8.50	8.50	8.45	8.20
	9.0		6.20	6.10	6.05	6.00	6.90	7.05	7.05	7.00
	10.0			4.80	4.70	4.70	5.60	5.90	5.90	5.90
	11.0			3.80	3.70	3.65	4.55	4.90	5.00	5.00
	12.0			3.00	2.90	2.85	3.70	4.15	4.20	4.25
	13.0			2.30	2.15	2.10	3.00	3.45	3.55	3.60
14.0				1.50	1.40	2.45	2.90	3.00	3.05	
15.0				0.95	0.90	1.90	2.40	2.50	2.60	
16.0						1.40	1.95	2.10	2.15	
17.0							1.55	1.70	1.80	
危険 角度	[°]	—	—	—	21	43	53	59	62	64
標準 フック	[ton]	40*/35					35			
フック 質量	[kg]	470*/330					330			
巻掛 本数	[本]	10*/7					7	4		

(単位: ton)

通常伸縮 カウンタウイト無	ブーム	ジブ	アウトリガ 2.55m	作業範囲
------------------	-----	----	----------------	------

[m]		10.0	13.0	17.0	20.0	24.0
[m]	2.3	20.00	17.50	15.00	13.50	12.00
	2.5	20.00	17.50	15.00	13.50	12.00
	3.0	20.00	17.50	15.00	13.50	12.00
	3.5	15.20	15.10	15.00	13.50	12.00
	4.0	11.90	11.75	11.60	11.50	11.10
	4.5	9.50	9.40	9.30	9.10	9.20
	5.0	7.80	7.70	7.60	7.40	7.50
	5.5	6.50	6.40	6.30	6.10	6.20
	6.0	5.50	5.35	5.20	5.10	5.10
	6.5	4.60	4.50	4.40	4.30	4.30
	7.0		3.80	3.70	3.60	3.60
8.0		2.70	2.60	2.50	2.50	
9.0		1.90	1.80	1.70		
10.0			1.20			
危険 角度	[°]	—	—	41	55	64
標準 フック	[ton]	35				
フック 質量	[kg]	330				
巻掛 本数	[本]	4				





(単位: ton)















SL-850RfII 24mブーム+SLジブ定格総荷重表

通常伸縮 カウンタウエイト無	ブーム 	ジブ 9.52m	アウトリガ 前方	作業範囲
-------------------	---------	-----------------	-----------------	----------





[m] [°] [°]	24.0							
	5		25		45		60	
	[m]	[ton]	[m]	[ton]	[m]	[ton]	[m]	[ton]
84	2.8	4.20	5.8	3.50	7.8	2.20	8.7	1.50
81	4.6	4.20	7.5	3.50	9.4	2.20	10.2	1.50
78	6.4	4.20	9.2	3.45	11.0	2.20	11.6	1.50
75	8.2	4.20	10.8	3.25	12.5	2.15	13.0	1.50
72	9.9	4.20	12.4	3.05	13.9	2.10	14.3	1.45
69	11.6	4.15	13.9	2.90	15.3	2.05	15.5	1.45
66	13.2	3.95	15.4	2.75	16.6	2.00	16.7	1.45
63	14.8	3.60	16.8	2.65	17.8	2.00	17.9	1.40
62	15.3	3.50	17.2	2.65	18.2	1.95	18.3	1.40
60	16.3	3.35	18.1	2.55	19.0	1.95		
57	17.7	3.10	19.4	2.50	20.1	1.95		
54	19.1	2.90	20.7	2.40	21.2	1.95		
51	20.4	2.75	21.8	2.30	22.2	1.90		
48	21.6	2.60	22.9	2.20	23.2	1.90		
45	22.8	2.40	23.9	2.10				
42	23.9	2.15	24.9	2.05				
39	24.9	1.95	25.8	1.95				
36	25.9	1.75	26.6	1.75				
33	26.8	1.60	27.3	1.60				
30	27.6	1.45	27.9	1.45				
28	28.1	1.40	28.3	1.40				
27	28.3	1.35						
24	28.9	1.25						
21	29.5	1.20						
18	29.9	1.10						
15	30.3	1.05						
危険 角度 標準 フック フック 質量 巻掛 本数	[°]	14	27	47	61			
	[ton]			5.6				
	[kg]			120				
	[本]			1				













通常伸縮 カウンタウエイト無	ブーム 	ジブ  9.52m	アウトリガ  7.6m	作業範囲 
-------------------	--	---	--	---





 [m]	24.0								
	5		25		45		60		
	 [m]	 [ton]	 [m]	 [ton]	 [m]	 [ton]	 [m]	 [ton]	
84	2.8	4.20	5.8	3.50	7.8	2.20	8.7	1.50	
81	4.6	4.20	7.5	3.50	9.4	2.20	10.2	1.50	
78	6.4	4.20	9.2	3.45	11.0	2.20	11.6	1.50	
75	8.2	4.20	10.8	3.25	12.5	2.15	13.0	1.50	
72	9.9	4.20	12.4	3.05	13.9	2.10	14.3	1.45	
69	11.6	4.15	13.9	2.90	15.3	2.05	15.5	1.45	
66	13.2	3.95	15.4	2.75	16.6	2.00	16.7	1.45	
63	14.8	3.60	16.8	2.65	17.8	2.00	17.9	1.40	
62	15.3	3.50	17.2	2.65	18.2	1.95	18.3	1.40	
60	16.3	3.35	18.1	2.55	19.0	1.95			
57	17.7	3.10	19.4	2.50	20.1	1.95			
54	19.1	2.90	20.7	2.40	21.2	1.95			
51	20.4	2.75	21.8	2.30	22.2	1.90			
48	21.6	2.55	22.9	2.20	23.2	1.90			
45	22.8	2.20	23.9	2.05					
42	23.9	1.90	24.9	1.80					
39	24.9	1.65	25.8	1.55					
36	25.9	1.35	26.6	1.30					
33	26.8	1.10	27.3	1.10					
30	27.5	0.90	27.9	0.85					
28	28.0	0.75	28.3	0.70					
27	28.3	0.70							
24	28.9	0.55							
22	29.2	0.50							
 危険 角度	[°]	21		27		47		61	
 標準 フック	[ton]	5.6							
 フック 質量	[kg]	120							
 巻掛 本数	[本]	1							



















SL-850RfII 24mブーム+SLジブ定格総荷重表















通常伸縮 カウンタウエイト無	ブーム 	ジブ  9.52m	アウトリガ  7.2m	作業範囲 
-------------------	--	---	--	---





 [m]	24.0								
	5		25		45		60		
	 [m]	 [ton]	 [m]	 [ton]	 [m]	 [ton]	 [m]	 [ton]	
84	2.8	4.20	5.8	3.50	7.8	2.20	8.7	1.50	
81	4.6	4.20	7.5	3.50	9.4	2.20	10.2	1.50	
78	6.4	4.20	9.2	3.45	11.0	2.20	11.6	1.50	
75	8.2	4.20	10.8	3.25	12.5	2.15	13.0	1.50	
72	9.9	4.20	12.4	3.05	13.9	2.10	14.3	1.45	
69	11.6	4.15	13.9	2.90	15.3	2.05	15.5	1.45	
66	13.2	3.95	15.4	2.75	16.6	2.00	16.7	1.45	
63	14.8	3.60	16.8	2.65	17.8	2.00	17.9	1.40	
62	15.3	3.50	17.2	2.65	18.2	1.95	18.3	1.40	
60	16.3	3.35	18.1	2.55	19.0	1.95			
57	17.7	3.10	19.4	2.50	20.1	1.95			
54	19.1	2.90	20.7	2.40	21.2	1.95			
51	20.4	2.70	21.8	2.30	22.2	1.90			
48	21.6	2.25	22.9	2.10	23.2	1.90			
45	22.8	1.90	23.9	1.80					
42	23.9	1.60	24.9	1.55					
39	24.9	1.30	25.8	1.25					
36	25.9	1.00	26.5	1.00					
33	26.7	0.80	27.2	0.80					
30	27.5	0.60	27.9	0.55					
28	28.0	0.45	28.2	0.45					
27	28.3	0.40							
 危険 角度	[°]	26		27		47		61	
 標準 フック	[ton]	5.6							
 フック 質量	[kg]	120							
 巻掛 本数	[本]	1							















通常伸縮 カウンタウエイト無	ブーム 	ジブ  9.52m	アウトリガ  6.5m	作業範囲 
-------------------	--	---	--	---

 [m]	24.0							
	5		25		45		60	
	 [m]	 [ton]	 [m]	 [ton]	 [m]	 [ton]	 [m]	 [ton]
84	2.8	4.20	5.8	3.50	7.8	2.20	8.7	1.50
81	4.6	4.20	7.5	3.50	9.4	2.20	10.2	1.50
78	6.4	4.20	9.2	3.45	11.0	2.20	11.6	1.50
75	8.2	4.20	10.8	3.25	12.5	2.15	13.0	1.50
72	9.9	4.20	12.4	3.05	13.9	2.10	14.3	1.45
69	11.6	4.15	13.9	2.90	15.3	2.05	15.5	1.45
66	13.2	3.95	15.4	2.75	16.6	2.00	16.7	1.45
63	14.8	3.60	16.8	2.65	17.8	2.00	17.9	1.40
62	15.3	3.50	17.2	2.65	18.2	1.95	18.3	1.40
60	16.3	3.35	18.1	2.55	19.0	1.95		
57	17.7	3.05	19.4	2.50	20.1	1.95		
54	19.0	2.55	20.6	2.30	21.2	1.95		
51	20.3	2.10	21.8	1.90	22.2	1.85		
48	21.6	1.70	22.9	1.55	23.2	1.55		
45	22.7	1.35	23.9	1.25				
42	23.8	1.05	24.8	1.00				
39	24.9	0.70	25.7	0.70				
37	25.5	0.55	26.2	0.55				
36	25.8	0.50						
35	26.1	0.40						
 危険 角度 [°]	34		36		47		61	
 標準 フック [ton]	5.6							
 フック 質量 [kg]	120							
 巻掛 本数 [本]	1							

通常伸縮 カウンタウエイト無	ブーム 	ジブ  9.52m	アウトリガ  5.4m	作業範囲 
-------------------	--	---	--	---

 [m]	24.0							
	5		25		45		60	
								
 [°]	[m]	[ton]	[m]	[ton]	[m]	[ton]	[m]	[ton]
84	2.8	4.20	5.8	3.50	7.8	2.20	8.7	1.50
81	4.6	4.20	7.5	3.50	9.4	2.20	10.2	1.50
78	6.4	4.20	9.2	3.45	11.0	2.20	11.6	1.50
75	8.2	4.20	10.8	3.25	12.5	2.15	13.0	1.50
72	9.9	4.20	12.4	3.05	13.9	2.10	14.3	1.45
69	11.6	4.15	13.9	2.90	15.3	2.05	15.5	1.45
66	13.2	3.95	15.4	2.75	16.6	2.00	16.7	1.45
63	14.7	3.35	16.8	2.60	17.8	2.00	17.9	1.40
62	15.2	3.05	17.2	2.55	18.2	1.95	18.3	1.40
60	16.1	2.60	18.1	2.20	19.0	1.95		
57	17.5	2.05	19.3	1.80	20.1	1.65		
54	18.9	1.60	20.5	1.40	21.2	1.35		
51	20.2	1.15	21.7	1.00	22.2	0.95		
48	21.4	0.75	22.8	0.65	23.1	0.65		
47	21.9	0.60	23.2	0.50				
 危険 角度 [°]	46		46		47		61	
 標準 フック [ton]	5.6							
 フック 質量 [kg]	120							
 巻掛 本数 [本]	1							

通常伸縮 カウンタウエイト無	ブーム 	ジブ  9.52m	アウトリガ  4.3m	作業範囲 
-------------------	--	---	--	---

 [m]	24.0							
	5		25		45		60	
								
 [°]	[m]	[ton]	[m]	[ton]	[m]	[ton]	[m]	[ton]
84	2.8	4.20	5.8	3.50	7.8	2.20	8.7	1.50
81	4.6	4.20	7.5	3.50	9.4	2.20	10.2	1.50
78	6.4	4.20	9.2	3.45	11.0	2.20	11.6	1.50
75	8.2	4.20	10.8	3.25	12.5	2.15	13.0	1.50
72	9.9	4.20	12.4	3.05	13.9	2.10	14.3	1.45
69	11.5	3.85	13.8	2.85	15.3	2.05	15.5	1.45
66	13.1	2.80	15.3	2.25	16.6	1.90	16.7	1.45
63	14.6	2.05	16.7	1.70	17.8	1.55	17.9	1.40
62	15.1	1.85	17.1	1.55	18.2	1.40	18.3	1.40
60	16.1	1.45	18.0	1.25	19.0	1.10		
58	17.0	1.10						
 危険 角度 [°]	57		59		59		61	
 標準 フック [ton]	5.6							
 フック 質量 [kg]	120							
 巻掛 本数 [本]	1							







SL-850RfII 24mブーム+SLジブ定格総荷重表













通常伸縮 カウンタウエイト無	ブーム 	ジブ 13.8m	アウトリガ 前方	作業範囲
-------------------	---------	-----------------	-----------------	----------

危険 角度 標準 フック 質量 巻掛 本数	[°]	24.0							
		5		25		45		60	
		[m]	[ton]	[m]	[ton]	[m]	[ton]	[m]	[ton]
84		3.7	2.80	8.2	2.65	11.3	1.55	12.8	1.00
81		5.8	2.80	10.3	2.50	13.0	1.50	14.3	1.00
78		7.8	2.75	12.1	2.35	14.7	1.45	15.8	1.00
75		9.8	2.75	13.9	2.20	16.3	1.45	17.1	1.00
72		11.8	2.70	15.5	2.05	17.8	1.40	18.5	1.00
69		13.7	2.65	17.1	1.95	19.2	1.35	19.8	1.00
66		15.5	2.50	18.6	1.85	20.6	1.35	21.0	1.00
63		17.2	2.25	20.1	1.75	21.9	1.30		
60		18.9	2.10	21.6	1.65	23.2	1.30		
57		20.5	1.95	23.0	1.60	24.3	1.30		
54		22.1	1.80	24.4	1.55	25.4	1.25		
51		23.5	1.75	25.7	1.50	26.4	1.25		
49		24.5	1.65	26.5	1.45	27.1	1.25		
48		24.9	1.65	26.9	1.45				
45		26.2	1.60	28.1	1.40				
42		27.5	1.50	29.1	1.35				
39		28.6	1.45	30.0	1.35				
36		29.7	1.45	30.8	1.35				
33		30.7	1.40	31.5	1.30				
30		31.6	1.35	32.2	1.30				
27		32.4	1.35						
24		33.1	1.30						
21		33.6	1.30						
18		34.1	1.30						
17		34.3	1.30						
危険 角度	[°]	16		29		48		65	
標準 フック	[ton]	5.6							
質量	[kg]	120							
巻掛 本数	[本]	1							







SL-850RfII 24mブーム+SLジブ定格総荷重表













通常伸縮 カウンタウエイト無	ブーム 	ジブ  13.8m	アウトリガ  7.6m	作業範囲 
-------------------	--	---	--	---

[m]	24.0								
	5		25		45		60		
[°]									
[°]	[m]	[ton]	[m]	[ton]	[m]	[ton]	[m]	[ton]	
84	3.7	2.80	8.2	2.65	11.3	1.55	12.8	1.00	
81	5.8	2.80	10.3	2.50	13.0	1.50	14.3	1.00	
78	7.8	2.75	12.1	2.35	14.7	1.45	15.8	1.00	
75	9.8	2.75	13.9	2.20	16.3	1.45	17.1	1.00	
72	11.8	2.70	15.5	2.05	17.8	1.40	18.5	1.00	
69	13.7	2.65	17.1	1.95	19.2	1.35	19.8	1.00	
66	15.5	2.50	18.6	1.85	20.6	1.35	21.0	1.00	
63	17.2	2.25	20.1	1.75	21.9	1.30			
60	18.9	2.10	21.6	1.65	23.2	1.30			
57	20.5	1.95	23.0	1.60	24.3	1.30			
54	22.1	1.80	24.4	1.55	25.4	1.25			
51	23.5	1.75	25.7	1.50	26.4	1.25			
49	24.5	1.65	26.5	1.45	27.1	1.25			
48	24.9	1.65	26.9	1.45					
45	26.2	1.60	28.1	1.40					
42	27.5	1.50	29.1	1.35					
39	28.6	1.30	30.0	1.25					
36	29.7	1.05	30.8	1.05					
33	30.7	0.85	31.5	0.85					
30	31.5	0.70	32.2	0.60					
27	32.3	0.50							
 危険 角度 標準 フック	[°]	26		29		48		65	
 フック 質量	[ton]	5.6							
 質量	[kg]	120							
 巻掛 本数	[本]	1							







SL-850RfII 24mブーム+SLジブ定格総荷重表















通常伸縮 カウンタウエイト無	ブーム 	ジブ  13.8m	アウトリガ  7.2m	作業範囲 
-------------------	--	---	--	---

 [m]	24.0								
	5		25		45		60		
	 [m]	 [ton]	 [m]	 [ton]	 [m]	 [ton]	 [m]	 [ton]	
84	3.7	2.80	8.2	2.65	11.3	1.55	12.8	1.00	
81	5.8	2.80	10.3	2.50	13.0	1.50	14.3	1.00	
78	7.8	2.75	12.1	2.35	14.7	1.45	15.8	1.00	
75	9.8	2.75	13.9	2.20	16.3	1.45	17.1	1.00	
72	11.8	2.70	15.5	2.05	17.8	1.40	18.5	1.00	
69	13.7	2.65	17.1	1.95	19.2	1.35	19.8	1.00	
66	15.5	2.50	18.6	1.85	20.6	1.35	21.0	1.00	
63	17.2	2.25	20.1	1.75	21.9	1.30			
60	18.9	2.10	21.6	1.65	23.2	1.30			
57	20.5	1.95	23.0	1.60	24.3	1.30			
54	22.1	1.80	24.4	1.55	25.4	1.25			
51	23.5	1.75	25.7	1.50	26.4	1.25			
49	24.5	1.65	26.5	1.45	27.1	1.25			
48	24.9	1.65	26.9	1.45					
45	26.2	1.55	28.0	1.40					
42	27.4	1.30	29.1	1.20					
39	28.5	1.05	30.0	0.95					
36	29.6	0.80	30.8	0.80					
34	30.3	0.65	31.3	0.65					
33	30.6	0.60							
31	31.2	0.50							
 危険 角度	[°]	30		33		48		65	
 標準 フック	[ton]	5.6							
 フック 質量	[kg]	120							
 巻掛 本数	[本]	1							







SL-850RfII 24mブーム+SLジブ定格総荷重表









通常伸縮 カウンタウエイト無	ブーム 	ジブ  13.8m	アウトリガ  6.5m	作業範囲 
-------------------	--	---	--	---

 [m]	24.0							
	5		25		45		60	
 [°]								
	[m]	[ton]	[m]	[ton]	[m]	[ton]	[m]	[ton]
84	3.7	2.80	8.2	2.65	11.3	1.55	12.8	1.00
81	5.8	2.80	10.3	2.50	13.0	1.50	14.3	1.00
78	7.8	2.75	12.1	2.35	14.7	1.45	15.8	1.00
75	9.8	2.75	13.9	2.20	16.3	1.45	17.1	1.00
72	11.8	2.70	15.5	2.05	17.8	1.40	18.5	1.00
69	13.7	2.65	17.1	1.95	19.2	1.35	19.8	1.00
66	15.5	2.50	18.6	1.85	20.6	1.35	21.0	1.00
63	17.2	2.25	20.1	1.75	21.9	1.30		
60	18.9	2.10	21.6	1.65	23.2	1.30		
57	20.5	1.95	23.0	1.60	24.3	1.30		
54	22.1	1.80	24.4	1.55	25.4	1.25		
51	23.5	1.70	25.7	1.45	26.4	1.25		
49	24.4	1.50	26.5	1.35	27.1	1.25		
48	24.8	1.40	26.9	1.25				
45	26.1	1.05	28.0	0.95				
42	27.3	0.80	29.0	0.70				
39	28.5	0.55	29.9	0.50				
38	28.8	0.45	30.2	0.45				
37	29.2	0.40						
 危険 角度	36		37		48		65	
 標準 フック	[ton]		5.6					
 フック 質量	[kg]		120					
 巻掛 本数	[本]		1					







SL-850RfII 24mブーム+SLジブ定格総荷重表









通常伸縮 カウンタウエイト無	ブーム 	ジブ  13.8m	アウトリガ  5.4m	作業範囲 
-------------------	--	---	--	---





危険角度 標準フック フック質量 巻掛本数	危険角度 [°]	24.0							
		5		25		45		60	
		 [m]	 [ton]	 [m]	 [ton]	 [m]	 [ton]	 [m]	 [ton]
	84	3.7	2.80	8.2	2.65	11.3	1.55	12.8	1.00
	81	5.8	2.80	10.3	2.50	13.0	1.50	14.3	1.00
	78	7.8	2.75	12.1	2.35	14.7	1.45	15.8	1.00
	75	9.8	2.75	13.9	2.20	16.3	1.45	17.1	1.00
	72	11.8	2.70	15.5	2.05	17.8	1.40	18.5	1.00
	69	13.7	2.65	17.1	1.95	19.2	1.35	19.8	1.00
	66	15.5	2.50	18.6	1.85	20.6	1.35	21.0	1.00
	63	17.2	2.25	20.1	1.75	21.9	1.30		
	60	18.9	2.05	21.6	1.65	23.2	1.30		
	57	20.4	1.65	23.0	1.40	24.3	1.25		
	54	21.9	1.25	24.4	1.05	25.4	1.00		
	51	23.3	0.85	25.7	0.70	26.4	0.70		
	50	23.7	0.75	26.1	0.60	26.7	0.60		
	49	24.2	0.65						
	危険角度 [°]	48		49		49		65	
	標準フック [ton]	5.6							
	フック質量 [kg]	120							
	巻掛本数 [本]	1							



















SL-850RfII 24mブーム+SLジブ定格総荷重表















通常伸縮 カウンタウエイト無	ブーム 	ジブ  13.8m	アウトリガ  4.3m	作業範囲 
-------------------	--	---	--	---

危険角度 標準フック フック質量 巻掛本数	危険角度 [°]	24.0							
		5		25		45		60	
									
		[m]	[ton]	[m]	[ton]	[m]	[ton]	[m]	[ton]
	84	3.7	2.80	8.2	2.65	11.3	1.55	12.8	1.00
	81	5.8	2.80	10.3	2.50	13.0	1.50	14.3	1.00
	78	7.8	2.75	12.1	2.35	14.7	1.45	15.8	1.00
	75	9.8	2.75	13.9	2.20	16.3	1.45	17.1	1.00
	72	11.8	2.70	15.5	2.05	17.8	1.40	18.5	1.00
	69	13.7	2.65	17.1	1.95	19.2	1.35	19.8	1.00
	66	15.4	2.20	18.6	1.75	20.6	1.35	21.0	1.00
	63	17.1	1.60	20.1	1.30	21.9	1.15		
	61	18.1	1.35	21.1	1.05	22.7	0.95		
	60	18.6	1.20						
	59	19.1	1.05						
		58		60		60		65	
		5.6							
		120							
		1							

通常伸縮 カウンタウエイト無	ブーム 	ジブ  18.0m	アウトリガ  前方	作業範囲 
-------------------	--	---	--	---





 [m]	24.0							
	5		25		45		60	
 [°]								
	 [m]	 [ton]	 [m]	 [ton]	 [m]	 [ton]	 [m]	 [ton]
84	4.6	1.80	10.4	1.00	14.7	0.70	16.7	0.55
81	6.9	1.80	12.5	1.00	16.6	0.70	18.3	0.55
78	9.3	1.75	14.5	0.95	18.3	0.65	19.8	0.55
75	11.5	1.65	16.5	0.95	20.0	0.65	21.2	0.55
72	13.6	1.45	18.4	0.85	21.6	0.60	22.6	0.55
69	15.7	1.30	20.3	0.80	23.1	0.60	23.9	0.55
66	17.7	1.20	22.0	0.75	24.5	0.60	25.1	0.55
64	19.0	1.10	23.1	0.75	25.5	0.55	25.9	0.55
63	19.6	1.05	23.7	0.70	25.9	0.55		
60	21.4	0.95	25.3	0.70	27.2	0.55		
57	23.2	0.85	26.8	0.65	28.4	0.55		
54	24.9	0.80	28.2	0.60	29.6	0.55		
51	26.5	0.75	29.6	0.60	30.6	0.55		
49	27.6	0.70	30.4	0.60	31.2	0.55		
48	28.1	0.70	30.8	0.60				
45	29.6	0.65	32.0	0.60				
42	31.0	0.60	33.1	0.55				
39	32.3	0.60	34.0	0.55				
36	33.4	0.55	34.9	0.55				
33	34.5	0.55	35.7	0.55				
31	35.2	0.55	36.1	0.55				
30	35.5	0.55						
27	36.3	0.50						
24	37.1	0.50						
21	37.7	0.50						
18	38.3	0.50						
 危険 角度 標準 フック	[°]	17	30	48	63			
 フック 質量	[kg]			5.6				
 巻掛 本数	[本]			120				
				1				













通常伸縮 カウンタウエイト無	ブーム 	ジブ  18.0m	アウトリガ  7.6m	作業範囲 
-------------------	--	---	--	---





 [m]	24.0								
	5		25		45		60		
 [°]									
	[m]	[ton]	[m]	[ton]	[m]	[ton]	[m]	[ton]	
84	4.6	1.80	10.4	1.00	14.7	0.70	16.7	0.55	
81	6.9	1.80	12.5	1.00	16.6	0.70	18.3	0.55	
78	9.3	1.75	14.5	0.95	18.3	0.65	19.8	0.55	
75	11.5	1.65	16.5	0.95	20.0	0.65	21.2	0.55	
72	13.6	1.45	18.4	0.85	21.6	0.60	22.6	0.55	
69	15.7	1.30	20.3	0.80	23.1	0.60	23.9	0.55	
66	17.7	1.20	22.0	0.75	24.5	0.60	25.1	0.55	
64	19.0	1.10	23.1	0.75	25.5	0.55	25.9	0.55	
63	19.6	1.05	23.7	0.70	25.9	0.55			
60	21.4	0.95	25.3	0.70	27.2	0.55			
57	23.2	0.85	26.8	0.65	28.4	0.55			
54	24.9	0.80	28.2	0.60	29.6	0.55			
51	26.5	0.75	29.6	0.60	30.6	0.55			
49	27.6	0.70	30.4	0.60	31.2	0.55			
48	28.1	0.70	30.8	0.60					
45	29.6	0.65	32.0	0.60					
42	31.0	0.60	33.1	0.55					
39	32.3	0.60	34.0	0.55					
36	33.4	0.55	34.9	0.55					
33	34.5	0.55	35.7	0.55					
31	35.2	0.55	36.1	0.55					
30	35.5	0.50							
28	36.1	0.40							
 危険 角度	[°]	27		30		48		63	
 標準 フック	[ton]	5.6							
 フック 質量	[kg]	120							
 巻掛 本数	[本]	1							



















SL-850RfII 24mブーム+SLジブ定格総荷重表















通常伸縮 カウンタウエイト無	ブーム 	ジブ  18.0m	アウトリガ  7.2m	作業範囲 
-------------------	--	---	--	---





 [m]	24.0								
	5		25		45		60		
	 [m]	 [ton]	 [m]	 [ton]	 [m]	 [ton]	 [m]	 [ton]	
84	4.6	1.80	10.4	1.00	14.7	0.70	16.7	0.55	
81	6.9	1.80	12.5	1.00	16.6	0.70	18.3	0.55	
78	9.3	1.75	14.5	0.95	18.3	0.65	19.8	0.55	
75	11.5	1.65	16.5	0.95	20.0	0.65	21.2	0.55	
72	13.6	1.45	18.4	0.85	21.6	0.60	22.6	0.55	
69	15.7	1.30	20.3	0.80	23.1	0.60	23.9	0.55	
66	17.7	1.20	22.0	0.75	24.5	0.60	25.1	0.55	
64	19.0	1.10	23.1	0.75	25.5	0.55	25.9	0.55	
63	19.6	1.05	23.7	0.70	25.9	0.55			
60	21.4	0.95	25.3	0.70	27.2	0.55			
57	23.2	0.85	26.8	0.65	28.4	0.55			
54	24.9	0.80	28.2	0.60	29.6	0.55			
51	26.5	0.75	29.6	0.60	30.6	0.55			
49	27.6	0.70	30.4	0.60	31.2	0.55			
48	28.1	0.70	30.8	0.60					
45	29.6	0.65	32.0	0.60					
42	31.0	0.60	33.1	0.55					
39	32.3	0.60	34.0	0.55					
36	33.4	0.55	34.9	0.55					
35	33.8	0.50	35.2	0.50					
33	34.5	0.45							
 危険 角度 標準 フック	[°]	32		34		48		63	
 フック 質量	[kg]	120							
 巻掛 本数	[本]	1							















通常伸縮 カウンタウエイト無	ブーム 	ジブ  18.0m	アウトリガ  6.5m	作業範囲 
-------------------	--	---	--	---

 [m]	24.0								
	5		25		45		60		
 [°]									
	[m]	[ton]	[m]	[ton]	[m]	[ton]	[m]	[ton]	
84	4.6	1.80	10.4	1.00	14.7	0.70	16.7	0.55	
81	6.9	1.80	12.5	1.00	16.6	0.70	18.3	0.55	
78	9.3	1.75	14.5	0.95	18.3	0.65	19.8	0.55	
75	11.5	1.65	16.5	0.95	20.0	0.65	21.2	0.55	
72	13.6	1.45	18.4	0.85	21.6	0.60	22.6	0.55	
69	15.7	1.30	20.3	0.80	23.1	0.60	23.9	0.55	
66	17.7	1.20	22.0	0.75	24.5	0.60	25.1	0.55	
64	19.0	1.10	23.1	0.75	25.5	0.55	25.9	0.55	
63	19.6	1.05	23.7	0.70	25.9	0.55			
60	21.4	0.95	25.3	0.70	27.2	0.55			
57	23.2	0.85	26.8	0.65	28.4	0.55			
54	24.9	0.80	28.2	0.60	29.6	0.55			
51	26.5	0.75	29.6	0.60	30.6	0.55			
49	27.6	0.70	30.4	0.60	31.2	0.55			
48	28.1	0.70	30.8	0.60					
45	29.6	0.65	32.0	0.60					
42	31.0	0.55	33.1	0.55					
41	31.4	0.50	33.4	0.50					
 危険角度 標準フック	[°]	40	40	40	48	48	63	63	
 フック質量	[kg]	120							
 巻掛本数	[本]	1							

通常伸縮 カウンタウエイト無	ブーム 	ジブ  18.0m	アウトリガ  5.4m	作業範囲 
-------------------	--	---	--	---

 [m]	24.0							
	5		25		45		60	
								
 [°]	[m]	[ton]	[m]	[ton]	[m]	[ton]	[m]	[ton]
84	4.6	1.80	10.4	1.00	14.7	0.70	16.7	0.55
81	6.9	1.80	12.5	1.00	16.6	0.70	18.3	0.55
78	9.3	1.75	14.5	0.95	18.3	0.65	19.8	0.55
75	11.5	1.65	16.5	0.95	20.0	0.65	21.2	0.55
72	13.6	1.45	18.4	0.85	21.6	0.60	22.6	0.55
69	15.7	1.30	20.3	0.80	23.1	0.60	23.9	0.55
66	17.7	1.20	22.0	0.75	24.5	0.60	25.1	0.55
64	19.0	1.10	23.1	0.75	25.5	0.55	25.9	0.55
63	19.6	1.05	23.7	0.70	25.9	0.55		
60	21.4	0.95	25.3	0.70	27.2	0.55		
57	23.2	0.85	26.8	0.65	28.4	0.55		
54	24.9	0.80	28.2	0.60	29.6	0.55		
51	26.5	0.65	29.6	0.50	30.6	0.50		
50	27.1	0.50	30.0	0.45	30.9	0.45		
49	27.6	0.40						
 危険 角度 [°]	48		49		49		63	
 標準 フック [ton]	5.6							
 フック 質量 [kg]	120							
 巻掛 本数 [本]	1							

通常伸縮 カウンタウエイト無	ブーム 	ジブ  18.0m	アウトリガ  4.3m	作業範囲 
-------------------	--	---	--	---

 [m]	24.0							
	5		25		45		60	
								
 [°]	[m]	[ton]	[m]	[ton]	[m]	[ton]	[m]	[ton]
84	4.6	1.80	10.4	1.00	14.7	0.70	16.7	0.55
81	6.9	1.80	12.5	1.00	16.6	0.70	18.3	0.55
78	9.3	1.75	14.5	0.95	18.3	0.65	19.8	0.55
75	11.5	1.65	16.5	0.95	20.0	0.65	21.2	0.55
72	13.6	1.45	18.4	0.85	21.6	0.60	22.6	0.55
69	15.7	1.30	20.3	0.80	23.1	0.60	23.9	0.55
66	17.7	1.20	22.0	0.75	24.5	0.60	25.1	0.55
64	19.0	1.10	23.1	0.75	25.5	0.55	25.9	0.55
63	19.6	1.05	23.7	0.70	25.9	0.55		
62	20.2	1.00	24.2	0.70	26.4	0.55		
60	21.4	0.90						
 危険 角度 [°]	59		61		61		63	
 標準 フック [ton]	5.6							
 フック 質量 [kg]	120							
 巻掛 本数 [本]	1							



SL-850RfII 45mブーム+SLジブ定格総荷重表





通常伸縮 カウンタウエイト無	ブーム 	ジブ 9.52m	アウトリガ 前方	作業範囲
-------------------	---------	-----------------	-----------------	----------













[m]	45.0							
	5		25		45		60	
	[m]	[ton]	[m]	[ton]	[m]	[ton]	[m]	[ton]
84	6.4	4.00	10.1	3.50	11.3	2.20	12.2	1.50
81	10.0	4.00	13.5	3.45	14.3	2.20	15.0	1.50
78	13.4	4.00	16.6	3.30	17.2	2.15	17.6	1.50
75	16.7	4.00	19.4	3.00	20.1	2.10	20.1	1.45
72	19.8	3.55	22.1	2.75	22.9	2.05	22.6	1.45
69	22.6	3.00	24.6	2.45	25.4	2.00	25.0	1.45
66	25.2	2.60	27.0	2.15	27.8	1.95	27.2	1.45
64	26.8	2.40	28.6	2.00	29.2	1.85	28.7	1.40
63	27.6	2.25	29.3	1.95	29.9	1.80		
60	29.9	2.00	31.5	1.70	31.8	1.65		
57	32.2	1.75	33.6	1.55	33.7	1.50		
54	34.3	1.55	35.5	1.40	35.6	1.40		
51	36.4	1.20	37.4	1.20	37.4	1.20		
49	37.5	1.00	38.4	1.00	38.4	1.00		
48	38.1	0.90	39.1	0.90				
45	39.8	0.65	40.6	0.65				
42	41.4	0.40	42.1	0.40				
危険角度 [°]	41		41		48		63	
標準フック [ton]	5.6							
フック質量 [kg]	120							
巻掛本数 [本]	1							





通常伸縮 カウンタウエイト無	ブーム 	ジブ 9.52m	アウトリガ 7.6m	作業範囲
-------------------	---------	-----------------	-------------------	----------













[m]	45.0							
	5		25		45		60	
	[m]	[ton]	[m]	[ton]	[m]	[ton]	[m]	[ton]
84	6.4	4.00	10.1	3.50	11.3	2.20	12.2	1.50
81	10.0	4.00	13.5	3.45	14.3	2.20	15.0	1.50
78	13.4	4.00	16.6	3.30	17.2	2.15	17.6	1.50
75	16.7	4.00	19.4	3.00	20.1	2.10	20.1	1.45
72	19.8	3.55	22.1	2.75	22.9	2.05	22.6	1.45
69	22.6	2.75	24.6	2.40	25.4	2.00	25.0	1.45
66	24.7	2.20	27.0	1.90	27.7	1.85	27.2	1.45
64	26.1	1.85	28.0	1.65	29.0	1.55	28.7	1.40
63	26.9	1.65	28.6	1.55	29.6	1.40		
60	29.0	1.20	30.6	1.10	31.5	1.05		
57	31.2	0.75	32.9	0.65	33.3	0.65		
危険角度 [°]	56		56		56		63	
標準フック [ton]	5.6							
フック質量 [kg]	120							
巻掛本数 [本]	1							





KATO SL-850RfII 45mブーム+SLジブ定格総荷重表









通常伸縮 カウンタウエイト無	ブーム 	ジブ  9.52m	アウトリガ  7.2m	作業範囲 
-------------------	--	---	--	---





 [m]	45.0							
	5		25		45		60	
	 [m]	 [ton]	 [m]	 [ton]	 [m]	 [ton]	 [m]	 [ton]
84	6.4	4.00	10.1	3.50	11.3	2.20	12.2	1.50
81	10.0	4.00	13.5	3.45	14.3	2.20	15.0	1.50
78	13.4	4.00	16.6	3.30	17.2	2.15	17.6	1.50
75	16.7	4.00	19.4	3.00	20.1	2.10	20.1	1.45
72	19.8	3.40	22.1	2.75	22.9	2.05	22.6	1.45
69	22.2	2.55	24.6	2.20	25.4	2.00	25.0	1.45
66	24.4	1.95	26.7	1.70	27.4	1.60	27.2	1.45
64	25.9	1.65	28.0	1.40	28.7	1.40	28.7	1.35
63	26.7	1.45	28.6	1.30	29.4	1.25		
60	28.9	0.95	30.6	0.85	31.5	0.80		
 危険角度 [°]	59		59		59		63	
 標準フック [ton]	5.6							
 フック質量 [kg]	120							
 巻掛本数 [本]	1							









通常伸縮 カウンタウエイト無	ブーム 	ジブ  9.52m	アウトリガ  6.5m	作業範囲 
-------------------	--	---	--	---

 [m]	45.0							
	5		25		45		60	
	 [m]	 [ton]	 [m]	 [ton]	 [m]	 [ton]	 [m]	 [ton]
84	6.4	4.00	10.1	3.50	11.3	2.20	12.2	1.50
81	10.0	4.00	13.5	3.45	14.3	2.20	15.0	1.50
78	13.4	4.00	16.6	3.30	17.2	2.15	17.6	1.50
75	16.7	3.90	19.4	3.00	20.1	2.10	20.1	1.45
72	19.8	2.75	22.1	2.35	22.9	2.05	22.6	1.45
69	21.7	2.15	23.9	1.85	25.0	1.65	25.0	1.45
66	24.1	1.55	26.2	1.35	27.0	1.30	27.0	1.30
64	25.8	1.10	27.8	0.95	28.5	0.95	28.5	0.95
 危険角度 [°]	63		63		63		63	
 標準フック [ton]	5.6							
 フック質量 [kg]	120							
 巻掛本数 [本]	1							





通常伸縮 カウンタウエイト無	ブーム 	ジブ  9.52m	アウトリガ  5.4m	作業範囲 
-------------------	--	---	--	---















ブーム長 [m]	45.0							
	5		25		45		60	
危険角度 [°]								
	[m]	[ton]	[m]	[ton]	[m]	[ton]	[m]	[ton]
84	6.4	4.00	10.1	3.50	11.3	2.20	12.2	1.50
81	10.0	4.00	13.5	3.45	14.3	2.20	15.0	1.50
78	13.4	4.00	16.6	3.20	17.2	2.15	17.6	1.50
75	16.7	2.85	19.4	2.25	20.1	2.10	20.1	1.45
72	18.9	2.05	21.1	1.75	22.4	1.50	22.6	1.45
71	19.7	1.80	21.9	1.55	23.1	1.45	23.4	1.40
70	20.5	1.55						
危険角度 [°]	69		70		70		70	
標準フック [ton]	5.6							
フック質量 [kg]	120							
巻掛本数 [本]	1							





通常伸縮 カウンタウエイト無	ブーム 	ジブ  9.52m	アウトリガ  4.3m	作業範囲 
-------------------	--	---	--	---















ブーム長 [m]	45.0							
	5		25		45		60	
危険角度 [°]								
	[m]	[ton]	[m]	[ton]	[m]	[ton]	[m]	[ton]
84	6.4	4.00	10.1	3.50	11.3	2.20	12.2	1.50
81	10.0	4.00	13.5	3.40	14.3	2.20	15.0	1.50
78	13.4	3.00	15.9	2.40	17.2	2.15	17.6	1.50
77	14.0	2.70	16.5	2.20	18.2	1.90	18.5	1.45
76	14.7	2.35	17.1	1.95				
75	15.3	2.10						
危険角度 [°]	74		75		76		76	
標準フック [ton]	5.6							
フック質量 [kg]	120							
巻掛本数 [本]	1							





KATO SL-850RfII 45mブーム+SLジブ定格総荷重表













通常伸縮 カウンタウエイト無	ブーム 	ジブ  13.8m	アウトリガ  前方	作業範囲 
-------------------	--	---	--	---





 [m]	45.0							
	5		25		45		60	
 [°]								
	 [m]	 [ton]	 [m]	 [ton]	 [m]	 [ton]	 [m]	 [ton]
84	7.4	2.80	12.4	2.60	15.0	1.50	16.0	1.00
81	11.4	2.75	15.7	2.40	17.9	1.45	18.8	1.00
78	15.0	2.70	18.9	2.20	20.8	1.40	21.5	1.00
75	18.4	2.70	21.8	2.05	23.7	1.35	24.1	1.00
72	21.5	2.65	24.7	1.90	26.5	1.35	26.6	1.00
69	24.6	2.45	27.4	1.80	29.1	1.30	29.0	1.00
66	27.4	2.15	30.0	1.70	31.5	1.30	31.2	1.00
64	29.2	1.95	31.7	1.55	33.0	1.30	32.7	1.00
63	30.1	1.85	32.6	1.50	33.7	1.25		
60	32.6	1.60	34.8	1.35	35.8	1.25		
57	35.0	1.40	37.0	1.20	37.8	1.15		
54	37.4	1.25	39.1	1.10	39.7	1.05		
51	39.6	1.05	41.2	1.00	41.5	0.95		
49	41.0	0.85	42.6	0.85	42.6	0.85		
48	41.4	0.80	43.2	0.75				
45	43.2	0.55	44.7	0.55				
43	44.3	0.40	45.8	0.40				
 危険角度 [°]	42		42		48		63	
 標準フック [ton]	5.6							
 フック質量 [kg]	120							
 巻掛本数 [本]	1							













通常伸縮 カウンタウエイト無	ブーム 	ジブ  13.8m	アウトリガ  7.6m	作業範囲 
-------------------	--	---	--	---





 [m]	45.0							
	5		25		45		60	
 [°]								
	 [m]	 [ton]	 [m]	 [ton]	 [m]	 [ton]	 [m]	 [ton]
84	7.4	2.80	12.4	2.60	15.0	1.50	16.0	1.00
81	11.4	2.75	15.7	2.40	17.9	1.45	18.8	1.00
78	15.0	2.70	18.9	2.20	20.8	1.40	21.5	1.00
75	18.4	2.70	21.8	2.05	23.7	1.35	24.1	1.00
72	21.5	2.65	24.7	1.90	26.5	1.35	26.6	1.00
69	24.6	2.40	27.4	1.80	29.1	1.30	29.0	1.00
66	27.4	1.85	30.0	1.65	31.5	1.30	31.2	1.00
64	28.8	1.60	31.7	1.40	33.0	1.30	32.7	1.00
63	29.6	1.45	32.4	1.25	33.7	1.20		
60	31.9	1.00	34.5	0.85	35.6	0.85		
58	33.3	0.75	35.8	0.65	36.8	0.65		
 危険角度 [°]	57		57		57		63	
 標準フック [ton]	5.6							
 フック質量 [kg]	120							
 巻掛本数 [本]	1							















通常伸縮 カウンタウエイト無	ブーム 	ジブ  13.8m	アウトリガ  7.2m	作業範囲 
-------------------	--	---	--	---





 [m]	45.0								
	5		25		45		60		
 [°]									
	 [m]	 [ton]	 [m]	 [ton]	 [m]	 [ton]	 [m]	 [ton]	
84	7.4	2.80	12.4	2.60	15.0	1.50	16.0	1.00	
81	11.4	2.75	15.7	2.40	17.9	1.45	18.8	1.00	
78	15.0	2.70	18.9	2.20	20.8	1.40	21.5	1.00	
75	18.4	2.70	21.8	2.05	23.7	1.35	24.1	1.00	
72	21.5	2.65	24.7	1.90	26.5	1.35	26.6	1.00	
69	24.6	2.20	27.4	1.80	29.1	1.30	29.0	1.00	
66	26.8	1.70	30.0	1.45	31.5	1.30	31.2	1.00	
64	28.4	1.40	31.3	1.20	33.0	1.10	32.7	1.00	
63	29.2	1.25	32.1	1.05	33.7	0.95			
61	30.8	0.95	33.6	0.80	34.8	0.75			
60	31.6	0.80							
 危険角度 標準 フック	[°]	59		60		60		63	
 フック 質量	[kg]	120							
 巻掛 本数	[本]	1							















通常伸縮 カウンタウエイト無	ブーム 	ジブ  13.8m	アウトリガ  6.5m	作業範囲 
-------------------	--	---	--	---





 [m]	45.0								
	5		25		45		60		
 [°]									
	 [m]	 [ton]	 [m]	 [ton]	 [m]	 [ton]	 [m]	 [ton]	
84	7.4	2.80	12.4	2.60	15.0	1.50	16.0	1.00	
81	11.4	2.75	15.7	2.40	17.9	1.45	18.8	1.00	
78	15.0	2.70	18.9	2.20	20.8	1.40	21.5	1.00	
75	18.4	2.70	21.8	2.05	23.7	1.35	24.1	1.00	
72	21.5	2.50	24.7	1.90	26.5	1.35	26.6	1.00	
69	24.0	1.85	27.4	1.50	29.1	1.30	29.0	1.00	
66	26.5	1.35	29.6	1.10	31.2	0.95	31.2	0.95	
65	27.3	1.15	30.3	0.95	31.8	0.90	31.9	0.90	
 危険角度 標準 フック	[°]	64		64		64		64	
 フック 質量	[kg]	120							
 巻掛 本数	[本]	1							













通常伸縮 カウンタウエイト無	ブーム 	ジブ  13.8m	アウトリガ  5.4m	作業範囲 
-------------------	--	---	--	---





 [m]	45.0							
 [°]	5		25		45		60	
 [°]								
	[m]	[ton]	[m]	[ton]	[m]	[ton]	[m]	[ton]
84	7.4	2.80	12.4	2.60	15.0	1.50	16.0	1.00
81	11.4	2.75	15.7	2.40	17.9	1.45	18.8	1.00
78	15.0	2.70	18.9	2.20	20.8	1.40	21.5	1.00
75	18.4	2.50	21.8	2.00	23.7	1.35	24.1	1.00
72	20.7	1.80	24.3	1.45	26.5	1.25	26.6	1.00
71	21.6	1.60	25.0	1.30				
 危険 角度 [°]	70		70		71		71	
 標準 フック [ton]	5.6							
 フック 質量 [kg]	120							
 巻掛 本数 [本]	1							













通常伸縮 カウンタウエイト無	ブーム 	ジブ  13.8m	アウトリガ  4.3m	作業範囲 
-------------------	--	---	--	---





 [m]	45.0							
 [°]	5		25		45		60	
 [°]								
	[m]	[ton]	[m]	[ton]	[m]	[ton]	[m]	[ton]
84	7.4	2.80	12.4	2.60	15.0	1.50	16.0	1.00
81	11.4	2.75	15.7	2.40	17.9	1.45	18.8	1.00
78	15.0	2.50	18.9	1.90	20.8	1.40	21.5	1.00
77	16.2	2.10	19.9	1.60	21.8	1.35	22.4	1.00
 危険 角度 [°]	76		76		76		76	
 標準 フック [ton]	5.6							
 フック 質量 [kg]	120							
 巻掛 本数 [本]	1							















通常伸縮 カウンタウエイト無	ブーム 	ジブ  18.0m	アウトリガ  前方	作業範囲 
-------------------	--	---	--	---





 [m]	45.0							
	5		25		45		60	
	 [m]	 [ton]	 [m]	 [ton]	 [m]	 [ton]	 [m]	 [ton]
84	8.5	1.80	14.3	1.00	18.3	0.70	20.1	0.55
81	12.5	1.75	17.9	1.00	21.5	0.65	23.0	0.55
78	16.3	1.50	21.3	0.95	24.5	0.60	25.7	0.55
75	19.7	1.30	24.5	0.85	27.4	0.60	28.3	0.55
72	22.9	1.20	27.5	0.80	30.2	0.55	30.8	0.55
69	26.0	1.10	30.3	0.75	32.8	0.55	33.1	0.55
66	29.0	1.00	33.0	0.70	35.2	0.55	35.4	0.55
65	30.0	1.00	33.9	0.70	36.0	0.55	36.1	0.55
63	32.0	0.95	35.7	0.65	37.6	0.55		
60	35.1	0.85	38.4	0.65	39.8	0.50		
57	37.7	0.80	40.5	0.60	41.9	0.50		
54	40.4	0.70	42.8	0.60	43.8	0.50		
51	43.0	0.65	45.2	0.55	45.6	0.50		
49	44.6	0.65	46.6	0.55	46.7	0.50		
48	45.4	0.60	47.3	0.55				
46	46.8	0.45	48.6	0.45				
 危険 角度 [°]	45		45		48		64	
 標準 フック [ton]	5.6							
 フック 質量 [kg]	120							
 巻掛 本数 [本]	1							















通常伸縮 カウンタウエイト無	ブーム 	ジブ  18.0m	アウトリガ  7.6m	作業範囲 
-------------------	--	---	--	---





 [m]	45.0							
	5		25		45		60	
	 [m]	 [ton]	 [m]	 [ton]	 [m]	 [ton]	 [m]	 [ton]
84	8.5	1.80	14.3	1.00	18.3	0.70	20.1	0.55
81	12.5	1.75	17.9	1.00	21.5	0.65	23.0	0.55
78	16.3	1.50	21.3	0.95	24.5	0.60	25.7	0.55
75	19.7	1.30	24.5	0.85	27.4	0.60	28.3	0.55
72	22.9	1.20	27.5	0.80	30.2	0.55	30.8	0.55
69	26.0	1.10	30.3	0.75	32.8	0.55	33.1	0.55
66	29.0	1.00	33.0	0.70	35.2	0.55	35.4	0.55
65	30.0	1.00	33.9	0.70	36.0	0.55	36.1	0.55
63	32.0	0.95	35.7	0.65	37.6	0.55		
60	35.1	0.75	38.4	0.60	39.8	0.50		
59	35.9	0.65	39.1	0.55	40.5	0.50		
 危険 角度 [°]	58		58		58		64	
 標準 フック [ton]	5.6							
 フック 質量 [kg]	120							
 巻掛 本数 [本]	1							











通常伸縮 カウンタウエイト無	ブーム 	ジブ  18.0m	アウトリガ  7.2m	作業範囲 
-------------------	--	---	--	---





 [m]	45.0							
	5		25		45		60	
 [°]								
	[m]	[ton]	[m]	[ton]	[m]	[ton]	[m]	[ton]
84	8.5	1.80	14.3	1.00	18.3	0.70	20.1	0.55
81	12.5	1.75	17.9	1.00	21.5	0.65	23.0	0.55
78	16.3	1.50	21.3	0.95	24.5	0.60	25.7	0.55
75	19.7	1.30	24.5	0.85	27.4	0.60	28.3	0.55
72	22.9	1.20	27.5	0.80	30.2	0.55	30.8	0.55
69	26.0	1.10	30.3	0.75	32.8	0.55	33.1	0.55
66	29.0	1.00	33.0	0.70	35.2	0.55	35.4	0.55
65	30.0	1.00	33.9	0.70	36.0	0.55	36.1	0.55
63	32.0	0.95	35.7	0.65	37.6	0.55		
62	33.0	0.85	36.7	0.60	38.4	0.55		
 危険角度 [°]	61		61		61		64	
 標準フック [ton]	5.6							
 フック質量 [kg]	120							
 巻掛本数 [本]	1							











通常伸縮 カウンタウエイト無	ブーム 	ジブ  18.0m	アウトリガ  6.5m	作業範囲 
-------------------	--	---	--	---

 [m]	45.0							
	5		25		45		60	
 [°]								
	[m]	[ton]	[m]	[ton]	[m]	[ton]	[m]	[ton]
84	8.5	1.80	14.3	1.00	18.3	0.70	20.1	0.55
81	12.5	1.75	17.9	1.00	21.5	0.65	23.0	0.55
78	16.3	1.50	21.3	0.95	24.5	0.60	25.7	0.55
75	19.7	1.30	24.5	0.85	27.4	0.60	28.3	0.55
72	22.9	1.20	27.5	0.80	30.2	0.55	30.8	0.55
69	26.0	1.10	30.3	0.75	32.8	0.55	33.1	0.55
66	29.0	1.00	33.0	0.70	35.2	0.55	35.4	0.55
65	30.0	0.90						
 危険角度 [°]	64		65		65		65	
 標準フック [ton]	5.6							
 フック質量 [kg]	120							
 巻掛本数 [本]	1							











通常伸縮 カウンタウエイト無	ブーム 	ジブ  18.0m	アウトリガ  5.4m	作業範囲 
-------------------	--	---	--	---

 [m]	45.0								
	5		25		45		60		
 [°]									
	[m]	[ton]	[m]	[ton]	[m]	[ton]	[m]	[ton]	
84	8.5	1.80	14.3	1.00	18.3	0.70	20.1	0.55	
81	12.5	1.75	17.9	1.00	21.5	0.65	23.0	0.55	
78	16.3	1.50	21.3	0.95	24.5	0.60	25.7	0.55	
75	19.7	1.30	24.5	0.85	27.4	0.60	28.3	0.55	
72	22.9	1.20	27.5	0.80	30.2	0.55	30.8	0.55	
71	23.9	1.15							
 危険 角度 標準 フック 質量 巻掛 本数	[°]	70		71		71		71	
	[ton]	5.6							
	[kg]	120							
	[本]	1							

通常伸縮 カウンタウエイト無	ブーム 	ジブ  18.0m	アウトリガ  4.3m	作業範囲 
-------------------	--	---	--	---

 [m]	45.0								
	5		25		45		60		
 [°]									
	[m]	[ton]	[m]	[ton]	[m]	[ton]	[m]	[ton]	
84	8.5	1.80	14.3	1.00	18.3	0.70	20.1	0.55	
81	12.5	1.75	17.9	1.00	21.5	0.65	23.0	0.55	
78	16.3	1.50	21.3	0.95	24.5	0.60	25.7	0.55	
77	17.4	1.40							
 危険 角度 標準 フック 質量 巻掛 本数	[°]	76		77		77		77	
	[ton]	5.6							
	[kg]	120							
	[本]	1							

ブーム (CW付) 定格総荷重表

		ブーム (CW付) 23
		24mブーム+SLジブ (CW付) 29
		45mブーム+SLジブ (CW付) 46
		ブーム【特殊伸縮】(CW付)... .. 58
		31m特殊伸縮ブーム+SLジブ (CW付) 64

KATO SL-850RfII ブーム (CW付) 定格総荷重表

通常伸縮 カウンタウエイト付	ブーム	ジブ	アウトリガ 前方	作業範囲
-------------------	-----	----	-------------	------

[m]	10.0	13.0	17.0	20.0	24.0	31.0	38.0	42.0	45.0
2.2	80.00#	40.00*	40.00*	38.00*					
2.3	75.00*	40.00*	40.00*	38.00*	35.00				
2.5	71.00*	40.00*	40.00*	38.00*	35.00	14.00			
3.0	63.00*	40.00*	40.00*	38.00*	35.00	14.00			
3.5	57.50*	40.00*	40.00*	38.00*	35.00	14.00	13.00		
4.0	52.00*	40.00*	40.00*	37.00*	32.50	14.00	13.00	10.20	
4.5	48.00*	40.00*	40.00*	34.00	30.30	14.00	13.00	10.20	8.20
5.0	44.00*	40.00*	39.00*	32.00	28.30	14.00	13.00	10.20	8.20
5.5	40.00	40.00*	37.00*	30.00	26.50	14.00	13.00	10.20	8.20
6.0	37.00	37.00*	35.00	28.50	24.90	14.00	13.00	10.20	8.20
6.5	34.00	34.00	32.70	27.00	23.50	14.00	13.00	10.20	8.20
7.0		31.30	30.50	25.50	22.20	14.00	13.00	10.20	8.20
8.0		26.90	26.00	23.00	19.90	14.00	13.00	10.20	8.20
9.0		23.50	23.00	21.00	18.10	14.00	13.00	10.20	8.20
10.0			20.50	19.50	16.50	14.00	12.70	10.20	8.20
11.0			18.50	17.70	15.10	13.10	12.10	10.20	8.20
12.0			16.50	16.20	13.90	12.10	11.10	10.20	8.20
13.0			14.50	14.50	12.90	11.10	10.20	9.55	8.20
14.0				13.10	11.90	10.30	9.50	8.95	8.10
15.0				11.90	11.10	9.60	8.80	8.45	7.70
16.0				10.80	10.30	9.00	8.20	7.95	7.20
17.0					9.65	8.40	7.60	7.45	6.75
18.0					9.00	7.90	6.90	6.85	6.30
19.0					8.10	7.45	6.50	6.35	5.90
20.0					7.30	7.00	6.10	5.85	5.50
21.0						6.50	5.70	5.40	5.20
22.0						6.15	5.40	5.10	4.90
23.0						5.85	5.10	4.75	4.55
24.0						5.50	4.80	4.50	4.30
26.0						4.80	4.30	4.00	3.90
28.0						4.10	3.85	3.60	3.50
30.0							3.45	3.20	3.10
32.0							3.15	2.95	2.80
33.0							3.00	2.80	2.65
34.0							2.85	2.65	2.55
36.0								2.45	2.30
38.0								2.20	2.10
40.0									1.90
41.0									1.80
危険 角度 標準 フック	[°]	-	-	-	-	-	-	-	-
フック 質量	[kg]	830*/470	470*/330			330			
巻掛 本数	[本]	20*/10	10*/7			7	4		

(単位: ton)

注 #: 前方左右各15°の旋回範囲のみ











SL-850RfII ブーム (CW付) 定格総荷重表

通常伸縮 カウンタウエイト付	ブーム	ジブ	アウトリガ 7.6m	作業範囲
-------------------	-----	----	---------------	------

[m]	通常伸縮 カウンタウエイト付									
	10.0	13.0	17.0	20.0	24.0	31.0	38.0	42.0	45.0	
2.3	75.00*	40.00*	40.00*	38.00*	35.00					
2.5	71.00*	40.00*	40.00*	38.00*	35.00	14.00				
3.0	63.00*	40.00*	40.00*	38.00*	35.00	14.00				
3.5	57.50*	40.00*	40.00*	38.00*	35.00	14.00	13.00			
4.0	52.00*	40.00*	40.00*	37.00*	32.50	14.00	13.00	10.20		
4.5	48.00*	40.00*	40.00*	34.00	30.30	14.00	13.00	10.20	8.20	
5.0	44.00*	40.00*	39.00*	32.00	28.30	14.00	13.00	10.20	8.20	
5.5	40.00	40.00*	37.00*	30.00	26.50	14.00	13.00	10.20	8.20	
6.0	37.00	37.00*	35.00	28.50	24.90	14.00	13.00	10.20	8.20	
6.5	34.00	34.00	32.70	27.00	23.50	14.00	13.00	10.20	8.20	
7.0		31.30	30.50	25.50	22.20	14.00	13.00	10.20	8.20	
8.0		26.90	26.00	23.00	19.90	14.00	13.00	10.20	8.20	
9.0		23.50	23.00	21.00	18.10	14.00	13.00	10.20	8.20	
10.0			18.90	18.75	16.50	14.00	12.70	10.20	8.20	
11.0			15.70	15.55	15.10	13.10	12.10	10.20	8.20	
12.0			13.25	13.15	13.10	12.10	11.10	10.20	8.20	
13.0			11.40	11.25	11.20	11.10	10.20	9.55	8.20	
14.0				9.70	9.65	10.30	9.50	8.95	8.10	
15.0				8.50	8.40	9.40	8.80	8.45	7.70	
16.0				7.45	7.35	8.30	8.20	7.95	7.20	
17.0					6.45	7.40	7.60	7.45	6.75	
18.0					5.65	6.60	6.90	6.85	6.30	
19.0					4.95	5.90	6.40	6.35	5.90	
20.0					4.35	5.25	5.80	5.85	5.50	
21.0						4.70	5.20	5.40	5.20	
22.0						4.20	4.70	4.95	4.90	
23.0						3.75	4.25	4.45	4.55	
24.0						3.35	3.85	4.05	4.15	
26.0						2.70	3.15	3.35	3.45	
28.0						2.15	2.55	2.75	2.90	
30.0							2.10	2.25	2.40	
32.0							1.65	1.85	1.95	
33.0							1.45	1.65	1.75	
34.0							1.30	1.45	1.60	
36.0								1.15	1.25	
38.0								0.85	0.95	
40.0									0.70	
危険 角度	[°]	—	—	—	—	—	—	—	—	—
標準 フック	[ton]	80*/40	40*/35			35				
フック 質量	[kg]	830*/470	470*/330			330				
巻掛 本数	[本]	20*/10	10*/7			7	4			





(単位 : ton)

通常伸縮 カウンタウエイト付	ブーム 	ジブ	アウトリガ  7.2m	作業範囲 
-------------------	--	----	--	---



 [m]	10.0	13.0	17.0	20.0	24.0	31.0	38.0	42.0	45.0
2.3	55.00*	40.00*	40.00*	38.00*	35.00				
2.5	55.00*	40.00*	40.00*	38.00*	35.00	14.00			
3.0	55.00*	40.00*	40.00*	38.00*	35.00	14.00			
3.5	52.00*	40.00*	40.00*	38.00*	35.00	14.00	13.00		
4.0	48.00*	40.00*	40.00*	37.00*	32.50	14.00	13.00	10.20	
4.5	44.00*	40.00*	40.00*	34.00	30.30	14.00	13.00	10.20	8.20
5.0	40.00	40.00*	39.00*	32.00	28.30	14.00	13.00	10.20	8.20
5.5	36.00	36.00*	36.00*	30.00	26.50	14.00	13.00	10.20	8.20
6.0	33.10	33.10	33.10	28.50	24.90	14.00	13.00	10.20	8.20
6.5	30.70	30.70	30.70	27.00	23.50	14.00	13.00	10.20	8.20
7.0		28.60	28.60	25.50	22.20	14.00	13.00	10.20	8.20
8.0		25.00	25.00	23.00	19.90	14.00	13.00	10.20	8.20
9.0		21.30	21.05	20.90	18.10	14.00	13.00	10.20	8.20
10.0			17.15	17.00	16.50	14.00	12.70	10.20	8.20
11.0			14.25	14.10	14.10	13.10	12.10	10.20	8.20
12.0			12.05	11.95	11.90	12.10	11.10	10.20	8.20
13.0			10.35	10.20	10.15	11.10	10.20	9.55	8.20
14.0				8.80	8.75	9.75	9.50	8.95	8.10
15.0				7.65	7.60	8.55	8.80	8.45	7.70
16.0				6.75	6.65	7.55	8.20	7.95	7.20
17.0					5.80	6.70	7.20	7.45	6.75
18.0					5.05	6.00	6.45	6.85	6.30
19.0					4.40	5.35	5.80	6.00	5.90
20.0					3.85	4.75	5.25	5.45	5.50
21.0						4.20	4.75	4.95	5.20
22.0						3.75	4.25	4.50	4.60
23.0						3.35	3.85	4.05	4.20
24.0						2.95	3.45	3.65	3.75
26.0						2.35	2.80	3.00	3.10
28.0						1.80	2.25	2.45	2.55
30.0							1.80	2.00	2.10
32.0							1.35	1.55	1.70
33.0							1.20	1.40	1.50
34.0							1.00	1.20	1.30
36.0								0.90	1.00
38.0									0.70
 [m]									
 危険 角度	[°]	—	—	—	—	—	—	—	13
 標準 フック	[ton]	80*/40	40*/35			35			
 フック 質量	[kg]	830*/470	470*/330			330			
 巻掛 本数	[本]	20*/10	10*/7			7	4		





(単位 : ton)

通常伸縮 カウンタウエイト付	ブーム	ジブ	アウトリガ 6.5m	作業範囲 (!)
-------------------	-----	----	---------------	-------------



[m]		10.0	13.0	17.0	20.0	24.0	31.0	38.0	42.0	45.0
 [m]	2.3	50.00*	40.00*	40.00*	38.00*	35.00				
	2.5	50.00*	40.00*	40.00*	38.00*	35.00	14.00			
	3.0	50.00*	40.00*	40.00*	38.00*	35.00	14.00			
	3.5	50.00*	40.00*	40.00*	38.00*	35.00	14.00	13.00		
	4.0	44.00*	40.00*	40.00*	37.00*	32.50	14.00	13.00	10.20	
	4.5	40.00	40.00*	40.00*	34.00	30.30	14.00	13.00	10.20	8.20
	5.0	36.00	36.00*	36.00*	32.00	28.30	14.00	13.00	10.20	8.20
	5.5	33.20	33.20	33.20	30.00	26.50	14.00	13.00	10.20	8.20
	6.0	30.70	30.70	30.70	28.50	24.90	14.00	13.00	10.20	8.20
	6.5	28.50	28.50	28.50	27.00	23.50	14.00	13.00	10.20	8.20
	7.0		26.50	26.50	25.50	22.20	14.00	13.00	10.20	8.20
	8.0		22.40	22.15	22.00	19.90	14.00	13.00	10.20	8.20
	9.0		17.80	17.60	17.45	17.45	14.00	13.00	10.20	8.20
	10.0			14.35	14.25	14.20	14.00	12.70	10.20	8.20
	11.0			11.95	11.85	11.80	12.90	12.10	10.20	8.20
	12.0			10.15	10.00	9.95	11.00	11.10	10.20	8.20
	13.0			8.65	8.55	8.50	9.45	10.20	9.55	8.20
	14.0				7.35	7.30	8.25	8.75	8.95	8.10
	15.0				6.35	6.30	7.20	7.70	7.90	7.70
	16.0				5.55	5.45	6.35	6.85	7.05	7.20
	17.0					4.75	5.60	6.10	6.30	6.75
	18.0					4.05	5.00	5.45	5.65	5.75
	19.0					3.50	4.40	4.90	5.05	5.20
	20.0					3.00	3.90	4.40	4.55	4.70
	21.0						3.40	3.95	4.15	4.25
	22.0						3.00	3.50	3.70	3.85
	23.0						2.65	3.10	3.30	3.45
	24.0						2.30	2.80	3.00	3.10
	26.0						1.70	2.20	2.40	2.50
	28.0						1.20	1.70	1.90	2.00
	30.0							1.25	1.45	1.60
	32.0							0.85	1.05	1.20
	33.0							0.70	0.90	1.00
	34.0								0.75	0.85
 危険 角度	[°]	—	—	—	—	—	—	—	21	28
 標準 フック	[ton]	80*/40	40*/35				35			
 フック 質量	[kg]	830*/470	470*/330				330			
 巻掛 本数	[本]	20*/10	10*/7			7	4			





(単位 : ton)

通常伸縮 カウンタウエイト付	ブーム 	ジブ	アウトリガ  5.4m	作業範囲 
-------------------	--	----	--	---





 [m]	10.0	13.0	17.0	20.0	24.0	31.0	38.0	42.0	45.0	
2.3	50.00*	40.00*	40.00*	38.00*	35.00					
2.5	50.00*	40.00*	40.00*	38.00*	35.00	14.00				
3.0	50.00*	40.00*	40.00*	38.00*	35.00	14.00				
3.5	46.00*	40.00*	40.00*	38.00*	35.00	14.00	13.00			
4.0	42.00*	40.00*	40.00*	37.00*	32.50	14.00	13.00	10.20		
4.5	37.20	37.20*	37.20*	34.00	30.30	14.00	13.00	10.20	8.20	
5.0	33.90	33.90	33.90	32.00	28.30	14.00	13.00	10.20	8.20	
5.5	30.80	30.80	30.60	30.00	26.50	14.00	13.00	10.20	8.20	
6.0	28.80	28.80	28.30	28.00	24.90	14.00	13.00	10.20	8.20	
6.5	24.45	24.30	24.05	23.90	23.15	14.00	13.00	10.20	8.20	
7.0		21.05	20.80	20.65	20.60	14.00	13.00	10.20	8.20	
8.0		16.35	16.10	16.00	15.95	14.00	13.00	10.20	8.20	
9.0		13.10	12.90	12.75	12.75	13.85	13.00	10.20	8.20	
10.0			10.55	10.45	10.40	11.45	11.85	10.20	8.20	
11.0			8.80	8.65	8.65	9.65	10.15	10.20	8.20	
12.0			7.40	7.30	7.25	8.20	8.70	8.90	8.20	
13.0			6.30	6.15	6.15	7.05	7.55	7.75	7.85	
14.0				5.25	5.20	6.10	6.55	6.75	6.90	
15.0				4.50	4.45	5.30	5.75	5.95	6.05	
16.0				3.85	3.80	4.60	5.05	5.25	5.35	
17.0					3.15	4.05	4.50	4.65	4.75	
18.0					2.60	3.50	3.95	4.15	4.25	
19.0					2.10	3.00	3.50	3.70	3.80	
20.0					1.70	2.60	3.10	3.30	3.40	
21.0						2.20	2.70	2.95	3.05	
22.0						1.85	2.35	2.55	2.70	
23.0						1.55	2.05	2.25	2.35	
24.0						1.25	1.75	1.95	2.10	
26.0						0.70	1.25	1.45	1.60	
28.0							0.80	1.00	1.10	
30.0									0.75	
 危険 角度	[°]	—	—	—	—	—	10	31	37	40
 標準 フック	[ton]	80*/40	40*/35			35				
 フック 質量	[kg]	830*/470	470*/330			330				
 巻掛 本数	[本]	20*/10	10*/7			7	4			















(単位 : ton)





通常伸縮 カウンタウエイト付	ブーム 	ジブ	アウトリガ  4.3m	作業範囲 
-------------------	---	----	---	--









 [m]	10.0	13.0	17.0	20.0	24.0	31.0	38.0	42.0	45.0	
2.3	40.00*	40.00*	40.00*	38.00*	35.00					
2.5	40.00*	40.00*	40.00*	38.00*	35.00	14.00				
3.0	40.00*	40.00*	40.00*	38.00*	35.00	14.00				
3.5	40.00*	40.00*	40.00*	38.00*	35.00	14.00	13.00			
4.0	37.10*	37.00*	36.90*	36.80*	32.50	14.00	13.00	10.20		
4.5	33.50	33.40	33.05	30.85	28.60	14.00	13.00	10.20	8.20	
5.0	27.70	27.60	27.35	26.20	24.45	14.00	13.00	10.20	8.20	
5.5	23.05	22.95	22.70	22.55	21.20	14.00	13.00	10.20	8.20	
6.0	19.60	19.50	19.25	19.10	18.60	14.00	13.00	10.20	8.20	
6.5	16.95	16.80	16.60	16.45	16.45	14.00	13.00	10.20	8.20	
7.0		14.65	14.45	14.35	14.35	14.00	13.00	10.20	8.20	
8.0		11.50	11.30	11.20	11.15	12.15	12.00	10.20	8.20	
9.0		9.25	9.05	8.95	8.90	9.90	10.15	10.05	8.20	
10.0			7.35	7.25	7.25	8.20	8.65	8.60	8.20	
11.0			6.05	5.95	5.95	6.85	7.35	7.45	7.45	
12.0			5.05	4.95	4.90	5.80	6.25	6.45	6.50	
13.0			4.20	4.10	4.05	4.90	5.35	5.55	5.65	
14.0				3.40	3.35	4.20	4.65	4.80	4.95	
15.0				2.80	2.70	3.55	4.00	4.20	4.30	
16.0				2.20	2.15	3.05	3.50	3.65	3.75	
17.0					1.60	2.60	3.00	3.20	3.30	
18.0					1.15	2.15	2.60	2.80	2.90	
19.0					0.75	1.70	2.25	2.45	2.55	
20.0						1.35	1.90	2.05	2.20	
21.0						1.00	1.55	1.75	1.90	
22.0						0.70	1.25	1.45	1.60	
23.0							0.95	1.20	1.30	
24.0							0.70	0.95	1.05	
 危険 角度 [°]	—	—	—	—	19	35	46	50	53	
 標準 フック [ton]	40*/35					35				
 フック 質量 [kg]	470*/330					330				
 巻掛 本数 [本]	10*/7					7	4			





(単位 : ton)













通常伸縮 カウンタウエイト付	ブーム 	ジブ  9.52m	アウトリガ  前方	作業範囲 
-------------------	--	---	--	---

 [m]	24.0							
	5		25		45		60	
 [°]								
	[m]	[ton]	[m]	[ton]	[m]	[ton]	[m]	[ton]
84	2.8	4.20	5.8	3.50	7.8	2.20	8.7	1.50
81	4.6	4.20	7.5	3.50	9.4	2.20	10.2	1.50
78	6.4	4.20	9.2	3.45	11.0	2.20	11.6	1.50
75	8.2	4.20	10.8	3.25	12.5	2.15	13.0	1.50
72	9.9	4.20	12.4	3.05	13.9	2.10	14.3	1.45
69	11.6	4.15	13.9	2.90	15.3	2.05	15.5	1.45
66	13.2	3.95	15.4	2.75	16.6	2.00	16.7	1.45
63	14.8	3.60	16.8	2.65	17.8	2.00	17.9	1.40
62	15.3	3.50	17.2	2.65	18.2	1.95	18.3	1.40
60	16.3	3.35	18.1	2.55	19.0	1.95		
57	17.7	3.10	19.4	2.50	20.1	1.95		
54	19.1	2.90	20.7	2.40	21.2	1.95		
51	20.4	2.75	21.8	2.30	22.2	1.90		
48	21.6	2.60	22.9	2.20	23.2	1.90		
45	22.8	2.40	23.9	2.10				
42	23.9	2.15	24.9	2.05				
39	24.9	1.95	25.8	1.95				
36	25.9	1.75	26.6	1.75				
33	26.8	1.60	27.3	1.60				
30	27.6	1.45	27.9	1.45				
28	28.1	1.40	28.3	1.40				
27	28.3	1.35						
24	28.9	1.25						
21	29.5	1.20						
18	29.9	1.10						
15	30.3	1.05						
 危険 角度	[°]	14		27		47		61
 標準 フック	[ton]	5.6						
 フック 質量	[kg]	120						
 巻掛 本数	[本]	1						

通常伸縮 カウンタウエイト付	ブーム 	ジブ  9.52m	アウトリガ  7.6m	作業範囲 
-------------------	--	---	--	---





危険角度 標準フック 質量 巻掛本数	危険 角度 標準 フック 質量 巻掛 本数	24.0							
		5		25		45		60	
									
		[m]	[ton]	[m]	[ton]	[m]	[ton]	[m]	[ton]
84		2.8	4.20	5.8	3.50	7.8	2.20	8.7	1.50
81		4.6	4.20	7.5	3.50	9.4	2.20	10.2	1.50
78		6.4	4.20	9.2	3.45	11.0	2.20	11.6	1.50
75		8.2	4.20	10.8	3.25	12.5	2.15	13.0	1.50
72		9.9	4.20	12.4	3.05	13.9	2.10	14.3	1.45
69		11.6	4.15	13.9	2.90	15.3	2.05	15.5	1.45
66		13.2	3.95	15.4	2.75	16.6	2.00	16.7	1.45
63		14.8	3.60	16.8	2.65	17.8	2.00	17.9	1.40
62		15.3	3.50	17.2	2.65	18.2	1.95	18.3	1.40
60		16.3	3.35	18.1	2.55	19.0	1.95		
57		17.7	3.10	19.4	2.50	20.1	1.95		
54		19.1	2.90	20.7	2.40	21.2	1.95		
51		20.4	2.75	21.8	2.30	22.2	1.90		
48		21.6	2.60	22.9	2.20	23.2	1.90		
45		22.8	2.40	23.9	2.10				
42		23.9	2.15	24.9	2.05				
39		24.9	1.95	25.8	1.95				
36		25.9	1.75	26.6	1.75				
33		26.8	1.60	27.3	1.60				
30		27.6	1.45	27.9	1.45				
28		28.1	1.40	28.3	1.40				
27		28.3	1.35						
24		28.9	1.25						
21		29.5	1.20						
18		29.9	1.10						
15		30.3	1.05						
	危険 角度 標準 フック 質量 巻掛 本数		14		27		47		61
	危険 角度 標準 フック 質量 巻掛 本数					5.6			
	危険 角度 標準 フック 質量 巻掛 本数					120			
	危険 角度 標準 フック 質量 巻掛 本数					1			

通常伸縮 カウンタウエイト付	ブーム 	ジブ  9.52m	アウトリガ  7.2m	作業範囲 
-------------------	--	---	--	---





 [m]	24.0							
	5		25		45		60	
 [°]								
	[m]	[ton]	[m]	[ton]	[m]	[ton]	[m]	[ton]
84	2.8	4.20	5.8	3.50	7.8	2.20	8.7	1.50
81	4.6	4.20	7.5	3.50	9.4	2.20	10.2	1.50
78	6.4	4.20	9.2	3.45	11.0	2.20	11.6	1.50
75	8.2	4.20	10.8	3.25	12.5	2.15	13.0	1.50
72	9.9	4.20	12.4	3.05	13.9	2.10	14.3	1.45
69	11.6	4.15	13.9	2.90	15.3	2.05	15.5	1.45
66	13.2	3.95	15.4	2.75	16.6	2.00	16.7	1.45
63	14.8	3.60	16.8	2.65	17.8	2.00	17.9	1.40
62	15.3	3.50	17.2	2.65	18.2	1.95	18.3	1.40
60	16.3	3.35	18.1	2.55	19.0	1.95		
57	17.7	3.10	19.4	2.50	20.1	1.95		
54	19.1	2.90	20.7	2.40	21.2	1.95		
51	20.4	2.75	21.8	2.30	22.2	1.90		
48	21.6	2.60	22.9	2.20	23.2	1.90		
45	22.8	2.40	23.9	2.10				
42	23.9	2.15	24.9	2.05				
39	24.9	1.95	25.8	1.95				
36	25.9	1.75	26.6	1.75				
33	26.8	1.60	27.3	1.60				
30	27.6	1.45	27.9	1.45				
28	28.1	1.40	28.3	1.40				
27	28.3	1.35						
24	28.9	1.25						
21	29.5	1.20						
18	29.9	1.10						
15	30.3	1.05						
 危険 角度 標準 フック	[°]	14	27	47	61			
 フック 質量	[kg]			5.6				
 巻掛 本数	[本]			120				
				1				

















SL-850RfII 24mブーム+SLジブ (CW付) 定格総荷重表

通常伸縮 カウンタウエイト付	ブーム 	ジブ  9.52m	アウトリガ  6.5m	作業範囲 
-------------------	--	---	--	---





危険角度 標準フック 質量 巻掛本数	危険 角度 標準 フック 質量 巻掛 本数	24.0							
		5		25		45		60	
	[°]	[m]	[ton]	[m]	[ton]	[m]	[ton]	[m]	[ton]
84		2.8	4.20	5.8	3.50	7.8	2.20	8.7	1.50
81		4.6	4.20	7.5	3.50	9.4	2.20	10.2	1.50
78		6.4	4.20	9.2	3.45	11.0	2.20	11.6	1.50
75		8.2	4.20	10.8	3.25	12.5	2.15	13.0	1.50
72		9.9	4.20	12.4	3.05	13.9	2.10	14.3	1.45
69		11.6	4.15	13.9	2.90	15.3	2.05	15.5	1.45
66		13.2	3.95	15.4	2.75	16.6	2.00	16.7	1.45
63		14.8	3.60	16.8	2.65	17.8	2.00	17.9	1.40
62		15.3	3.50	17.2	2.65	18.2	1.95	18.3	1.40
60		16.3	3.35	18.1	2.55	19.0	1.95		
57		17.7	3.10	19.4	2.50	20.1	1.95		
54		19.1	2.90	20.7	2.40	21.2	1.95		
51		20.4	2.75	21.8	2.30	22.2	1.90		
48		21.6	2.60	22.9	2.20	23.2	1.90		
45		22.8	2.40	23.9	2.10				
42		23.9	2.15	24.9	2.00				
39		24.9	1.90	25.8	1.80				
36		25.9	1.70	26.6	1.60				
33		26.8	1.45	27.3	1.45				
30		27.6	1.20	27.9	1.20				
28		28.1	1.10	28.3	1.05				
27		28.3	1.05						
24		28.9	0.90						
21		29.5	0.75						
18		29.9	0.65						
15		30.3	0.55						
危険角度	[°]	14		27		47		61	
標準フック	[ton]	5.6							
フック質量	[kg]	120							
巻掛本数	[本]	1							









通常伸縮 カウンタウエイト付	ブーム 	ジブ  9.52m	アウトリガ  5.4m	作業範囲 
-------------------	--	---	--	---





 [m]	24.0							
	5		25		45		60	
 [°]								
	[m]	[ton]	[m]	[ton]	[m]	[ton]	[m]	[ton]
84	2.8	4.20	5.8	3.50	7.8	2.20	8.7	1.50
81	4.6	4.20	7.5	3.50	9.4	2.20	10.2	1.50
78	6.4	4.20	9.2	3.45	11.0	2.20	11.6	1.50
75	8.2	4.20	10.8	3.25	12.5	2.15	13.0	1.50
72	9.9	4.20	12.4	3.05	13.9	2.10	14.3	1.45
69	11.6	4.15	13.9	2.90	15.3	2.05	15.5	1.45
66	13.2	3.95	15.4	2.75	16.6	2.00	16.7	1.45
63	14.8	3.60	16.8	2.65	17.8	2.00	17.9	1.40
62	15.3	3.50	17.2	2.65	18.2	1.95	18.3	1.40
60	16.3	3.35	18.1	2.55	19.0	1.95		
57	17.7	3.10	19.4	2.50	20.1	1.95		
54	19.1	2.70	20.7	2.35	21.2	1.95		
51	20.3	2.30	21.8	2.10	22.2	1.90		
48	21.5	1.95	22.9	1.75	23.1	1.75		
45	22.7	1.60	23.9	1.50				
42	23.8	1.30	24.9	1.20				
39	24.8	1.00	25.7	1.00				
36	25.8	0.75	26.5	0.75				
33	26.7	0.55	27.2	0.55				
31	27.2	0.40						
 危険 角度	30		32		47		61	
 標準 フック	5.6							
 フック 質量	120							
 巻掛 本数	1							

















SL-850RfII 24mブーム+SLジブ (CW付) 定格総荷重表

通常伸縮 カウンタウエイト付	ブーム 	ジブ  9.52m	アウトリガ  4.3m	作業範囲 
-------------------	--	---	--	---





危険角度 標準フック フック質量 巻掛本数	危険 角度 [°]	24.0							
		5		25		45		60	
		 [m]	 [ton]	 [m]	 [ton]	 [m]	 [ton]	 [m]	 [ton]
	84	2.8	4.20	5.8	3.50	7.8	2.20	8.7	1.50
	81	4.6	4.20	7.5	3.50	9.4	2.20	10.2	1.50
	78	6.4	4.20	9.2	3.45	11.0	2.20	11.6	1.50
	75	8.2	4.20	10.8	3.25	12.5	2.15	13.0	1.50
	72	9.9	4.20	12.4	3.05	13.9	2.10	14.3	1.45
	69	11.6	4.15	13.9	2.90	15.3	2.05	15.5	1.45
	66	13.2	3.95	15.4	2.75	16.6	2.00	16.7	1.45
	63	14.7	3.40	16.8	2.65	17.8	2.00	17.9	1.40
	62	15.2	3.15	17.2	2.65	18.2	1.95	18.3	1.40
	60	16.1	2.70	18.1	2.30	19.0	1.95		
	57	17.5	2.15	19.3	1.90	20.1	1.75		
	54	18.9	1.70	20.6	1.50	21.2	1.45		
	51	20.2	1.35	21.7	1.20	22.2	1.15		
	48	21.5	0.90	22.8	0.85	23.1	0.85		
	45	22.7	0.55	23.9	0.50				
	44	23.1	0.45	24.2	0.40				
		43		43		47		61	
		5.6							
		120							
		1							













通常伸縮 カウンタウエイト付	ブーム 	ジブ  13.8m	アウトリガ  前方	作業範囲 
-------------------	--	---	--	---

 [m]	24.0							
	5		25		45		60	
 [°]								
	[m]	[ton]	[m]	[ton]	[m]	[ton]	[m]	[ton]
84	3.7	2.80	8.2	2.65	11.3	1.55	12.8	1.00
81	5.8	2.80	10.3	2.50	13.0	1.50	14.3	1.00
78	7.8	2.75	12.1	2.35	14.7	1.45	15.8	1.00
75	9.8	2.75	13.9	2.20	16.3	1.45	17.1	1.00
72	11.8	2.70	15.5	2.05	17.8	1.40	18.5	1.00
69	13.7	2.65	17.1	1.95	19.2	1.35	19.8	1.00
66	15.5	2.50	18.6	1.85	20.6	1.35	21.0	1.00
63	17.2	2.25	20.1	1.75	21.9	1.30		
60	18.9	2.10	21.6	1.65	23.2	1.30		
57	20.5	1.95	23.0	1.60	24.3	1.30		
54	22.1	1.80	24.4	1.55	25.4	1.25		
51	23.5	1.75	25.7	1.50	26.4	1.25		
49	24.5	1.65	26.5	1.45	27.1	1.25		
48	24.9	1.65	26.9	1.45				
45	26.2	1.60	28.1	1.40				
42	27.5	1.50	29.1	1.35				
39	28.6	1.45	30.0	1.35				
36	29.7	1.45	30.8	1.35				
33	30.7	1.40	31.5	1.30				
30	31.6	1.35	32.2	1.30				
27	32.4	1.35						
24	33.1	1.30						
21	33.6	1.30						
18	34.1	1.30						
17	34.3	1.30						
 危険 角度	[°]	16		29		48		65
 標準 フック	[ton]	5.6						
 フック 質量	[kg]	120						
 巻掛 本数	[本]	1						





















SL-850RfII 24mブーム+SLジブ (CW付) 定格総荷重表

通常伸縮 カウンタウエイト付	ブーム 	ジブ  13.8m	アウトリガ  7.6m	作業範囲 
-------------------	--	---	--	---

 [m]	24.0								
	5		25		45		60		
	 [m]	 [ton]	 [m]	 [ton]	 [m]	 [ton]	 [m]	 [ton]	
84	3.7	2.80	8.2	2.65	11.3	1.55	12.8	1.00	
81	5.8	2.80	10.3	2.50	13.0	1.50	14.3	1.00	
78	7.8	2.75	12.1	2.35	14.7	1.45	15.8	1.00	
75	9.8	2.75	13.9	2.20	16.3	1.45	17.1	1.00	
72	11.8	2.70	15.5	2.05	17.8	1.40	18.5	1.00	
69	13.7	2.65	17.1	1.95	19.2	1.35	19.8	1.00	
66	15.5	2.50	18.6	1.85	20.6	1.35	21.0	1.00	
63	17.2	2.25	20.1	1.75	21.9	1.30			
60	18.9	2.10	21.6	1.65	23.2	1.30			
57	20.5	1.95	23.0	1.60	24.3	1.30			
54	22.1	1.80	24.4	1.55	25.4	1.25			
51	23.5	1.75	25.7	1.50	26.4	1.25			
49	24.5	1.65	26.5	1.45	27.1	1.25			
48	24.9	1.65	26.9	1.45					
45	26.2	1.60	28.1	1.40					
42	27.5	1.50	29.1	1.35					
39	28.6	1.45	30.0	1.35					
36	29.7	1.45	30.8	1.35					
33	30.7	1.40	31.5	1.30					
30	31.6	1.35	32.2	1.30					
27	32.4	1.35							
24	33.1	1.30							
21	33.6	1.25							
18	34.1	1.20							
17	34.3	1.20							
 危険 角度	[°]	16		29		48		65	
 標準 フック	[ton]	5.6							
 フック 質量	[kg]	120							
 巻掛 本数	[本]	1							





KATO SL-850RfII 24mブーム+SLジブ (CW付) 定格総荷重表













通常伸縮 カウンタウエイト付	ブーム 	ジブ  13.8m	アウトリガ  7.2m	作業範囲 
-------------------	--	---	--	---

 [m]	24.0								
	5		25		45		60		
 [°]									
	[m]	[ton]	[m]	[ton]	[m]	[ton]	[m]	[ton]	
84	3.7	2.80	8.2	2.65	11.3	1.55	12.8	1.00	
81	5.8	2.80	10.3	2.50	13.0	1.50	14.3	1.00	
78	7.8	2.75	12.1	2.35	14.7	1.45	15.8	1.00	
75	9.8	2.75	13.9	2.20	16.3	1.45	17.1	1.00	
72	11.8	2.70	15.5	2.05	17.8	1.40	18.5	1.00	
69	13.7	2.65	17.1	1.95	19.2	1.35	19.8	1.00	
66	15.5	2.50	18.6	1.85	20.6	1.35	21.0	1.00	
63	17.2	2.25	20.1	1.75	21.9	1.30			
60	18.9	2.10	21.6	1.65	23.2	1.30			
57	20.5	1.95	23.0	1.60	24.3	1.30			
54	22.1	1.80	24.4	1.55	25.4	1.25			
51	23.5	1.75	25.7	1.50	26.4	1.25			
49	24.5	1.65	26.5	1.45	27.1	1.25			
48	24.9	1.65	26.9	1.45					
45	26.2	1.60	28.1	1.40					
42	27.5	1.50	29.1	1.35					
39	28.6	1.45	30.0	1.35					
36	29.7	1.45	30.8	1.35					
33	30.7	1.40	31.5	1.30					
30	31.6	1.35	32.2	1.30					
27	32.4	1.30							
24	33.1	1.15							
21	33.6	1.05							
18	34.1	0.95							
17	34.3	0.90							
 危険 角度	[°]	16		29		48		65	
 標準 フック	[ton]	5.6							
 フック 質量	[kg]	120							
 巻掛 本数	[本]	1							



















SL-850RfII 24mブーム+SLジブ (CW付) 定格総荷重表





通常伸縮 カウンタウエイト付	ブーム 	ジブ  13.8m	アウトリガ  6.5m	作業範囲 
-------------------	--	---	--	---













 [m]	24.0							
	5		25		45		60	
	 [m]	 [ton]	 [m]	 [ton]	 [m]	 [ton]	 [m]	 [ton]
84	3.7	2.80	8.2	2.65	11.3	1.55	12.8	1.00
81	5.8	2.80	10.3	2.50	13.0	1.50	14.3	1.00
78	7.8	2.75	12.1	2.35	14.7	1.45	15.8	1.00
75	9.8	2.75	13.9	2.20	16.3	1.45	17.1	1.00
72	11.8	2.70	15.5	2.05	17.8	1.40	18.5	1.00
69	13.7	2.65	17.1	1.95	19.2	1.35	19.8	1.00
66	15.5	2.50	18.6	1.85	20.6	1.35	21.0	1.00
63	17.2	2.25	20.1	1.75	21.9	1.30		
60	18.9	2.10	21.6	1.65	23.2	1.30		
57	20.5	1.95	23.0	1.60	24.3	1.30		
54	22.1	1.80	24.4	1.55	25.4	1.25		
51	23.5	1.75	25.7	1.50	26.4	1.25		
49	24.5	1.65	26.5	1.45	27.1	1.25		
48	24.9	1.65	26.9	1.45				
45	26.2	1.60	28.1	1.40				
42	27.5	1.50	29.1	1.35				
39	28.6	1.45	30.0	1.35				
36	29.7	1.35	30.8	1.30				
33	30.6	1.20	31.5	1.15				
30	31.5	1.00	32.1	0.95				
27	32.3	0.80						
24	33.0	0.70						
21	33.6	0.60						
18	34.1	0.50						
17	34.3	0.45						
 危険 角度	[°]	16	29	48	65			
 標準 フック	[ton]			5.6				
 フック 質量	[kg]			120				
 巻掛 本数	[本]			1				





KATO SL-850RfII 24mブーム+SLジブ (CW付) 定格総荷重表













通常伸縮 カウンタウエイト付	ブーム 	ジブ  13.8m	アウトリガ  5.4m	作業範囲 
-------------------	--	---	--	---





 [m]	24.0							
	5		25		45		60	
	 [m]	 [ton]	 [m]	 [ton]	 [m]	 [ton]	 [m]	 [ton]
84	3.7	2.80	8.2	2.65	11.3	1.55	12.8	1.00
81	5.8	2.80	10.3	2.50	13.0	1.50	14.3	1.00
78	7.8	2.75	12.1	2.35	14.7	1.45	15.8	1.00
75	9.8	2.75	13.9	2.20	16.3	1.45	17.1	1.00
72	11.8	2.70	15.5	2.05	17.8	1.40	18.5	1.00
69	13.7	2.65	17.1	1.95	19.2	1.35	19.8	1.00
66	15.5	2.50	18.6	1.85	20.6	1.35	21.0	1.00
63	17.2	2.25	20.1	1.75	21.9	1.30		
60	18.9	2.10	21.6	1.65	23.2	1.30		
57	20.5	1.95	23.0	1.60	24.3	1.30		
54	22.1	1.80	24.4	1.55	25.4	1.25		
51	23.5	1.75	25.7	1.50	26.4	1.25		
49	24.5	1.65	26.5	1.45	27.1	1.25		
48	24.9	1.55	26.9	1.40				
45	26.2	1.30	28.0	1.20				
42	27.4	1.00	29.0	0.95				
39	28.5	0.80	29.9	0.75				
36	29.5	0.55	30.8	0.55				
34	30.2	0.45	31.2	0.45				
 危険角度 標準 フック	33		33		48		65	
 フック 質量	5.6							
 質量	120							
 巻掛 本数	1							













通常伸縮 カウンタウエイト付	ブーム 	ジブ  13.8m	アウトリガ  4.3m	作業範囲 
-------------------	--	---	--	---

 [m]	24.0							
	5		25		45		60	
	 [m]	 [ton]	 [m]	 [ton]	 [m]	 [ton]	 [m]	 [ton]
84	3.7	2.80	8.2	2.65	11.3	1.55	12.8	1.00
81	5.8	2.80	10.3	2.50	13.0	1.50	14.3	1.00
78	7.8	2.75	12.1	2.35	14.7	1.45	15.8	1.00
75	9.8	2.75	13.9	2.20	16.3	1.45	17.1	1.00
72	11.8	2.70	15.5	2.05	17.8	1.40	18.5	1.00
69	13.7	2.65	17.1	1.95	19.2	1.35	19.8	1.00
66	15.5	2.50	18.6	1.85	20.6	1.35	21.0	1.00
63	17.2	2.25	20.1	1.75	21.9	1.30		
60	18.9	2.10	21.6	1.65	23.2	1.30		
57	20.4	1.75	23.0	1.50	24.3	1.25		
54	21.9	1.40	24.3	1.20	25.4	1.15		
51	23.3	1.05	25.6	0.90	26.4	0.90		
49	24.2	0.80	26.4	0.70	27.1	0.70		
48	24.7	0.70	26.8	0.60				
47	25.1	0.60	27.2	0.50				
 危険角度	46		46		48		65	
 標準 フック	5.6							
 質量	120							
 巻掛 本数	1							

通常伸縮 カウンタウエイト付	ブーム 	ジブ  18.0m	アウトリガ  前方	作業範囲 
-------------------	--	---	--	---





 [m]	24.0							
	5		25		45		60	
 [°]								
	 [m]	 [ton]	 [m]	 [ton]	 [m]	 [ton]	 [m]	 [ton]
84	4.6	1.80	10.4	1.00	14.7	0.70	16.7	0.55
81	6.9	1.80	12.5	1.00	16.6	0.70	18.3	0.55
78	9.3	1.75	14.5	0.95	18.3	0.65	19.8	0.55
75	11.5	1.65	16.5	0.95	20.0	0.65	21.2	0.55
72	13.6	1.45	18.4	0.85	21.6	0.60	22.6	0.55
69	15.7	1.30	20.3	0.80	23.1	0.60	23.9	0.55
66	17.7	1.20	22.0	0.75	24.5	0.60	25.1	0.55
64	19.0	1.10	23.1	0.75	25.5	0.55	25.9	0.55
63	19.6	1.05	23.7	0.70	25.9	0.55		
60	21.4	0.95	25.3	0.70	27.2	0.55		
57	23.2	0.85	26.8	0.65	28.4	0.55		
54	24.9	0.80	28.2	0.60	29.6	0.55		
51	26.5	0.75	29.6	0.60	30.6	0.55		
49	27.6	0.70	30.4	0.60	31.2	0.55		
48	28.1	0.70	30.8	0.60				
45	29.6	0.65	32.0	0.60				
42	31.0	0.60	33.1	0.55				
39	32.3	0.60	34.0	0.55				
36	33.4	0.55	34.9	0.55				
33	34.5	0.55	35.7	0.55				
31	35.2	0.55	36.1	0.55				
30	35.5	0.55						
27	36.3	0.50						
24	37.1	0.50						
21	37.7	0.50						
18	38.3	0.50						
 危険 角度 標準 フック	[°]	17	30	48	63			
 フック 質量	[kg]			5.6				
 巻掛 本数	[本]			120				
				1				

通常伸縮 カウンタウエイト付	ブーム 	ジブ  18.0m	アウトリガ  7.6m	作業範囲 
-------------------	--	---	--	---

 [m]	24.0							
	5		25		45		60	
 [°]								
	[m]	[ton]	[m]	[ton]	[m]	[ton]	[m]	[ton]
84	4.6	1.80	10.4	1.00	14.7	0.70	16.7	0.55
81	6.9	1.80	12.5	1.00	16.6	0.70	18.3	0.55
78	9.3	1.75	14.5	0.95	18.3	0.65	19.8	0.55
75	11.5	1.65	16.5	0.95	20.0	0.65	21.2	0.55
72	13.6	1.45	18.4	0.85	21.6	0.60	22.6	0.55
69	15.7	1.30	20.3	0.80	23.1	0.60	23.9	0.55
66	17.7	1.20	22.0	0.75	24.5	0.60	25.1	0.55
64	19.0	1.10	23.1	0.75	25.5	0.55	25.9	0.55
63	19.6	1.05	23.7	0.70	25.9	0.55		
60	21.4	0.95	25.3	0.70	27.2	0.55		
57	23.2	0.85	26.8	0.65	28.4	0.55		
54	24.9	0.80	28.2	0.60	29.6	0.55		
51	26.5	0.75	29.6	0.60	30.6	0.55		
49	27.6	0.70	30.4	0.60	31.2	0.55		
48	28.1	0.70	30.8	0.60				
45	29.6	0.65	32.0	0.60				
42	31.0	0.60	33.1	0.55				
39	32.3	0.60	34.0	0.55				
36	33.4	0.55	34.9	0.55				
33	34.5	0.55	35.7	0.55				
31	35.2	0.55	36.1	0.55				
30	35.5	0.55						
27	36.3	0.50						
24	37.1	0.50						
21	37.7	0.50						
18	38.3	0.50						
 危険 角度 標準 フック	[°]	17		30		48		63
 フック 質量	[kg]	5.6						
 巻掛 本数	[本]	120						
		1						







SL-850RfII 24mブーム+SLジブ (CW付) 定格総荷重表















通常伸縮 カウンタウエイト付	ブーム 	ジブ  18.0m	アウトリガ  7.2m	作業範囲 
-------------------	--	---	--	---





危険角度 標準フック 質量 巻掛本数	危険 角度 標準 フック 質量 巻掛 本数	24.0							
		5		25		45		60	
	[°]	[m]	[ton]	[m]	[ton]	[m]	[ton]	[m]	[ton]
84	84	4.6	1.80	10.4	1.00	14.7	0.70	16.7	0.55
81	81	6.9	1.80	12.5	1.00	16.6	0.70	18.3	0.55
78	78	9.3	1.75	14.5	0.95	18.3	0.65	19.8	0.55
75	75	11.5	1.65	16.5	0.95	20.0	0.65	21.2	0.55
72	72	13.6	1.45	18.4	0.85	21.6	0.60	22.6	0.55
69	69	15.7	1.30	20.3	0.80	23.1	0.60	23.9	0.55
66	66	17.7	1.20	22.0	0.75	24.5	0.60	25.1	0.55
64	64	19.0	1.10	23.1	0.75	25.5	0.55	25.9	0.55
63	63	19.6	1.05	23.7	0.70	25.9	0.55		
60	60	21.4	0.95	25.3	0.70	27.2	0.55		
57	57	23.2	0.85	26.8	0.65	28.4	0.55		
54	54	24.9	0.80	28.2	0.60	29.6	0.55		
51	51	26.5	0.75	29.6	0.60	30.6	0.55		
49	49	27.6	0.70	30.4	0.60	31.2	0.55		
48	48	28.1	0.70	30.8	0.60				
45	45	29.6	0.65	32.0	0.60				
42	42	31.0	0.60	33.1	0.55				
39	39	32.3	0.60	34.0	0.55				
36	36	33.4	0.55	34.9	0.55				
33	33	34.5	0.55	35.7	0.55				
31	31	35.2	0.55	36.1	0.55				
30	30	35.5	0.55						
27	27	36.3	0.50						
24	24	37.1	0.50						
21	21	37.7	0.50						
18	18	38.3	0.50						
危険角度	[°]	17		30		48		63	
標準フック	[ton]	5.6							
フック質量	[kg]	120							
巻掛本数	[本]	1							



















SL-850RfII 24mブーム+SLジブ (CW付) 定格総荷重表















通常伸縮 カウンタウエイト付	ブーム 	ジブ  18.0m	アウトリガ  6.5m	作業範囲 
-------------------	--	---	--	---

 [m]	24.0							
	5		25		45		60	
 [°]								
	[m]	[ton]	[m]	[ton]	[m]	[ton]	[m]	[ton]
84	4.6	1.80	10.4	1.00	14.7	0.70	16.7	0.55
81	6.9	1.80	12.5	1.00	16.6	0.70	18.3	0.55
78	9.3	1.75	14.5	0.95	18.3	0.65	19.8	0.55
75	11.5	1.65	16.5	0.95	20.0	0.65	21.2	0.55
72	13.6	1.45	18.4	0.85	21.6	0.60	22.6	0.55
69	15.7	1.30	20.3	0.80	23.1	0.60	23.9	0.55
66	17.7	1.20	22.0	0.75	24.5	0.60	25.1	0.55
64	19.0	1.10	23.1	0.75	25.5	0.55	25.9	0.55
63	19.6	1.05	23.7	0.70	25.9	0.55		
60	21.4	0.95	25.3	0.70	27.2	0.55		
57	23.2	0.85	26.8	0.65	28.4	0.55		
54	24.9	0.80	28.2	0.60	29.6	0.55		
51	26.5	0.75	29.6	0.60	30.6	0.55		
49	27.6	0.70	30.4	0.60	31.2	0.55		
48	28.1	0.70	30.8	0.60				
45	29.6	0.65	32.0	0.60				
42	31.0	0.60	33.1	0.55				
39	32.3	0.60	34.0	0.55				
36	33.4	0.55	34.9	0.55				
33	34.5	0.55	35.7	0.55				
31	35.2	0.55	36.1	0.55				
30	35.5	0.55						
27	36.3	0.50						
24	37.1	0.50						
23	37.3	0.50						
 危険 角度	[°]	22		30		48		63
 標準 フック	[ton]	5.6						
 フック 質量	[kg]	120						
 巻掛 本数	[本]	1						

通常伸縮 カウンタウエイト付	ブーム 	ジブ  18.0m	アウトリガ  5.4m	作業範囲 
-------------------	--	---	--	---

 [m]	24.0								
	5		25		45		60		
	 [m]	 [ton]	 [m]	 [ton]	 [m]	 [ton]	 [m]	 [ton]	
84	4.6	1.80	10.4	1.00	14.7	0.70	16.7	0.55	
81	6.9	1.80	12.5	1.00	16.6	0.70	18.3	0.55	
78	9.3	1.75	14.5	0.95	18.3	0.65	19.8	0.55	
75	11.5	1.65	16.5	0.95	20.0	0.65	21.2	0.55	
72	13.6	1.45	18.4	0.85	21.6	0.60	22.6	0.55	
69	15.7	1.30	20.3	0.80	23.1	0.60	23.9	0.55	
66	17.7	1.20	22.0	0.75	24.5	0.60	25.1	0.55	
64	19.0	1.10	23.1	0.75	25.5	0.55	25.9	0.55	
63	19.6	1.05	23.7	0.70	25.9	0.55			
60	21.4	0.95	25.3	0.70	27.2	0.55			
57	23.2	0.85	26.8	0.65	28.4	0.55			
54	24.9	0.80	28.2	0.60	29.6	0.55			
51	26.5	0.75	29.6	0.60	30.6	0.55			
49	27.6	0.70	30.4	0.60	31.2	0.55			
48	28.1	0.70	30.8	0.60					
45	29.6	0.65	32.0	0.60					
42	31.0	0.60	33.1	0.55					
39	32.3	0.55	34.0	0.55					
38	32.7	0.50	34.3	0.50					
36	33.4	0.40							
 危険 角度	[°]	35		37		48		63	
 標準 フック	[ton]	5.6							
 フック 質量	[kg]	120							
 巻掛 本数	[本]	1							

通常伸縮 カウンタウエイト付	ブーム 	ジブ  18.0m	アウトリガ  4.3m	作業範囲 
-------------------	--	---	--	---

 [m]	24.0							
	5		25		45		60	
 [°]								
	[m]	[ton]	[m]	[ton]	[m]	[ton]	[m]	[ton]
84	4.6	1.80	10.4	1.00	14.7	0.70	16.7	0.55
81	6.9	1.80	12.5	1.00	16.6	0.70	18.3	0.55
78	9.3	1.75	14.5	0.95	18.3	0.65	19.8	0.55
75	11.5	1.65	16.5	0.95	20.0	0.65	21.2	0.55
72	13.6	1.45	18.4	0.85	21.6	0.60	22.6	0.55
69	15.7	1.30	20.3	0.80	23.1	0.60	23.9	0.55
66	17.7	1.20	22.0	0.75	24.5	0.60	25.1	0.55
64	19.0	1.10	23.1	0.75	25.5	0.55	25.9	0.55
63	19.6	1.05	23.7	0.70	25.9	0.55		
60	21.4	0.95	25.3	0.70	27.2	0.55		
57	23.2	0.85	26.8	0.65	28.4	0.55		
54	24.9	0.80	28.2	0.60	29.6	0.55		
51	26.5	0.70	29.6	0.60	30.6	0.55		
49	27.6	0.60	30.4	0.50	31.2	0.50		
48	28.1	0.50						
47	28.6	0.40						
 危険 角度 [°]	46		48		48		63	
 標準 フック [ton]	5.6							
 フック 質量 [kg]	120							
 巻掛 本数 [本]	1							







SL-850RfII 45mブーム+SLジブ (CW付) 定格総荷重表

通常伸縮 カウンタウエイト付	ブーム 	ジブ 9.52m	アウトリガ 前方	作業範囲
-------------------	---------	-----------------	-----------------	----------

[m]	45.0								
	5		25		45		60		
	[m]	[ton]	[m]	[ton]	[m]	[ton]	[m]	[ton]	
84	6.4	4.00	10.1	3.50	11.3	2.20	12.2	1.50	
81	10.0	4.00	13.5	3.45	14.3	2.20	15.0	1.50	
78	13.4	4.00	16.6	3.30	17.2	2.15	17.6	1.50	
75	16.7	4.00	19.4	3.00	20.1	2.10	20.1	1.45	
72	19.8	3.55	22.1	2.75	22.9	2.05	22.6	1.45	
69	22.6	3.00	24.6	2.45	25.4	2.00	25.0	1.45	
66	25.2	2.60	27.0	2.15	27.8	1.95	27.2	1.45	
64	26.8	2.40	28.6	2.00	29.2	1.85	28.7	1.40	
63	27.6	2.25	29.3	1.95	29.9	1.80			
60	29.9	2.00	31.5	1.70	31.8	1.65			
57	32.2	1.75	33.6	1.55	33.7	1.50			
54	34.3	1.55	35.5	1.40	35.6	1.40			
51	36.4	1.40	37.4	1.30	37.4	1.25			
49	37.7	1.30	38.5	1.20	38.5	1.20			
48	38.3	1.25	39.1	1.15					
45	40.1	1.10	40.8	1.05					
42	41.8	0.95	42.3	0.95					
39	43.4	0.85	43.8	0.85					
36	44.8	0.75	45.1	0.75					
33	46.1	0.65	46.3	0.65					
30	47.3	0.55	47.4	0.55					
27	48.4	0.40							
26	48.7	0.40							
危険 角度	[°]	25		29		48		63	
標準 フック	[ton]	5.6							
フック 質量	[kg]	120							
巻掛 本数	[本]	1							







SL-850RfII 45mブーム+SLジブ (CW付) 定格総荷重表















通常伸縮 カウンタウエイト付	ブーム 	ジブ  9.52m	アウトリガ  7.6m	作業範囲 
-------------------	--	---	--	---





危険 角度 標準 フック 質量 巻掛 本数	[m]	45.0							
		5		25		45		60	
		[m]	[ton]	[m]	[ton]	[m]	[ton]	[m]	[ton]
84	6.4	4.00	10.1	3.50	11.3	2.20	12.2	1.50	
81	10.0	4.00	13.5	3.45	14.3	2.20	15.0	1.50	
78	13.4	4.00	16.6	3.30	17.2	2.15	17.6	1.50	
75	16.7	4.00	19.4	3.00	20.1	2.10	20.1	1.45	
72	19.8	3.55	22.1	2.75	22.9	2.05	22.6	1.45	
69	22.6	3.00	24.6	2.45	25.4	2.00	25.0	1.45	
66	25.2	2.60	27.0	2.15	27.8	1.95	27.2	1.45	
64	26.8	2.40	28.6	2.00	29.2	1.85	28.7	1.40	
63	27.6	2.25	29.3	1.95	29.9	1.80			
60	29.9	2.00	31.5	1.70	31.8	1.65			
57	32.2	1.60	33.6	1.50	33.7	1.50			
54	34.0	1.25	35.5	1.20	35.6	1.20			
51	35.9	0.95	37.2	0.90	37.2	0.90			
49	37.2	0.70	38.2	0.70	38.2	0.70			
48	37.8	0.60	38.9	0.60					
46	39.0	0.45	39.9	0.45					
危険 角度 標準 フック 質量 巻掛 本数	[°]	45		45		48		63	
危険 角度 標準 フック 質量 巻掛 本数	[ton]	5.6							
危険 角度 標準 フック 質量 巻掛 本数	[kg]	120							
危険 角度 標準 フック 質量 巻掛 本数	[本]	1							

















SL-850RfII 45mブーム+SLジブ (CW付) 定格総荷重表





通常伸縮 カウンタウエイト付	ブーム 	ジブ  9.52m	アウトリガ  7.2m	作業範囲 
-------------------	--	---	--	---









 [m]	45.0							
	5		25		45		60	
								
 [°]	[m]	[ton]	[m]	[ton]	[m]	[ton]	[m]	[ton]
84	6.4	4.00	10.1	3.50	11.3	2.20	12.2	1.50
81	10.0	4.00	13.5	3.45	14.3	2.20	15.0	1.50
78	13.4	4.00	16.6	3.30	17.2	2.15	17.6	1.50
75	16.7	4.00	19.4	3.00	20.1	2.10	20.1	1.45
72	19.8	3.55	22.1	2.75	22.9	2.05	22.6	1.45
69	22.6	3.00	24.6	2.45	25.4	2.00	25.0	1.45
66	25.2	2.60	27.0	2.15	27.8	1.95	27.2	1.45
64	26.8	2.40	28.6	2.00	29.2	1.85	28.7	1.40
63	27.6	2.25	29.3	1.95	29.9	1.80		
60	29.9	1.80	31.5	1.65	31.8	1.65		
57	31.8	1.45	33.3	1.35	33.8	1.35		
54	33.8	1.05	35.2	1.00	35.5	1.00		
51	35.8	0.70	37.0	0.65	37.1	0.65		
49	37.1	0.50	38.2	0.50	38.2	0.50		
48	37.8	0.40	38.8	0.40				
 危険 角度 [°]	47		47		48		63	
 標準 フック [ton]	5.6							
 フック 質量 [kg]	120							
 巻掛 本数 [本]	1							





通常伸縮 カウンタウエイト付	ブーム 	ジブ  9.52m	アウトリガ  6.5m	作業範囲 
-------------------	--	---	--	---









 [m]	45.0							
	5		25		45		60	
								
 [°]	[m]	[ton]	[m]	[ton]	[m]	[ton]	[m]	[ton]
84	6.4	4.00	10.1	3.50	11.3	2.20	12.2	1.50
81	10.0	4.00	13.5	3.45	14.3	2.20	15.0	1.50
78	13.4	4.00	16.6	3.30	17.2	2.15	17.6	1.50
75	16.7	4.00	19.4	3.00	20.1	2.10	20.1	1.45
72	19.8	3.55	22.1	2.75	22.9	2.05	22.6	1.45
69	22.6	3.00	24.6	2.45	25.4	2.00	25.0	1.45
66	25.2	2.30	27.0	2.10	27.8	1.95	27.2	1.45
64	26.4	2.00	28.6	1.75	29.2	1.75	28.7	1.40
63	27.2	1.85	29.3	1.65	29.9	1.65		
60	29.3	1.45	30.9	1.35	31.6	1.30		
57	31.4	1.00	33.0	0.90	33.5	0.90		
54	33.6	0.60	35.0	0.55	35.3	0.55		
53	34.3	0.50	35.7	0.45	35.9	0.45		
 危険 角度 [°]	52		52		52		63	
 標準 フック [ton]	5.6							
 フック 質量 [kg]	120							
 巻掛 本数 [本]	1							

KATO SL-850RfII 45mブーム+SLジブ (CW付) 定格総荷重表

通常伸縮 カウンタウエイト付	ブーム 	ジブ  9.52m	アウトリガ  5.4m	作業範囲 
-------------------	--	---	--	---





[m]	45.0								
	5		25		45		60		
[°]									
[°]	[m]	[ton]	[m]	[ton]	[m]	[ton]	[m]	[ton]	
84	6.4	4.00	10.1	3.50	11.3	2.20	12.2	1.50	
81	10.0	4.00	13.5	3.45	14.3	2.20	15.0	1.50	
78	13.4	4.00	16.6	3.30	17.2	2.15	17.6	1.50	
75	16.7	3.95	19.4	3.00	20.1	2.10	20.1	1.45	
72	19.8	2.90	22.1	2.50	22.9	2.05	22.6	1.45	
69	21.8	2.30	23.8	2.05	25.4	1.85	25.0	1.45	
66	24.2	1.70	26.2	1.50	27.2	1.45	27.2	1.45	
64	25.8	1.35	27.8	1.20	28.5	1.20	28.7	1.15	
63	26.7	1.15	28.6	1.00	29.2	1.00			
62	27.5	0.95	29.4	0.85	30.0	0.85			
危険 角度 標準 フック	[°]	61		61		61		63	
フック 質量	[ton]	5.6							
巻掛 本数	[kg]	120							
	[本]	1							













通常伸縮 カウンタウエイト付	ブーム 	ジブ  9.52m	アウトリガ  4.3m	作業範囲 
-------------------	--	---	--	---

[m]	45.0								
	5		25		45		60		
[°]									
[°]	[m]	[ton]	[m]	[ton]	[m]	[ton]	[m]	[ton]	
84	6.4	4.00	10.1	3.50	11.3	2.20	12.2	1.50	
81	10.0	4.00	13.5	3.45	14.3	2.20	15.0	1.50	
78	13.4	4.00	16.6	3.25	17.2	2.15	17.6	1.50	
75	16.7	2.90	19.4	2.35	20.1	2.10	20.1	1.45	
72	18.9	2.15	21.0	1.90	22.4	1.60	22.6	1.45	
70	20.5	1.70	22.6	1.50	23.9	1.40	24.2	1.35	
69	21.2	1.50	23.5	1.30					
68	21.9	1.35							
危険 角度 標準 フック	[°]	67		68		69		69	
フック 質量	[ton]	5.6							
巻掛 本数	[kg]	120							
	[本]	1							







SL-850RfII 45mブーム+SLジブ (CW付) 定格総荷重表









通常伸縮 カウンタウエイト付	ブーム 	ジブ  13.8m	アウトリガ  前方	作業範囲 
-------------------	--	---	--	---





 [m]	45.0								
	5		25		45		60		
	 [m]	 [ton]	 [m]	 [ton]	 [m]	 [ton]	 [m]	 [ton]	
84	7.4	2.80	12.4	2.60	15.0	1.50	16.0	1.00	
81	11.4	2.75	15.7	2.40	17.9	1.45	18.8	1.00	
78	15.0	2.70	18.9	2.20	20.8	1.40	21.5	1.00	
75	18.4	2.70	21.8	2.05	23.7	1.35	24.1	1.00	
72	21.5	2.65	24.7	1.90	26.5	1.35	26.6	1.00	
69	24.6	2.45	27.4	1.80	29.1	1.30	29.0	1.00	
66	27.4	2.15	30.0	1.70	31.5	1.30	31.2	1.00	
64	29.2	1.95	31.7	1.55	33.0	1.30	32.7	1.00	
63	30.1	1.85	32.6	1.50	33.7	1.25			
60	32.6	1.60	34.8	1.35	35.8	1.25			
57	35.0	1.40	37.0	1.20	37.8	1.15			
54	37.4	1.25	39.1	1.10	39.7	1.05			
51	39.6	1.10	41.2	1.00	41.5	0.95			
49	41.0	1.05	42.6	0.90	42.6	0.90			
48	41.7	1.00	43.2	0.90					
45	43.6	0.90	45.0	0.80					
42	45.4	0.80	46.6	0.75					
39	47.1	0.70	48.0	0.70					
36	48.6	0.65	49.3	0.60					
33	50.0	0.55	50.4	0.55					
30	51.3	0.45	51.4	0.45					
29	51.7	0.40	51.7	0.40					
 危険 角度	[°]	28		28		48		63	
 標準 フック	[ton]	5.6							
 フック 質量	[kg]	120							
 巻掛 本数	[本]	1							



















SL-850RfII 45mブーム+SLジブ (CW付) 定格総荷重表













通常伸縮 カウンタウエイト付	ブーム 	ジブ  13.8m	アウトリガ  7.6m	作業範囲 
-------------------	--	---	--	---

危険角度 標準フック フック質量 巻掛本数	危険 角度 [°]	45.0							
		5		25		45		60	
									
		[m]	[ton]	[m]	[ton]	[m]	[ton]	[m]	[ton]
	84	7.4	2.80	12.4	2.60	15.0	1.50	16.0	1.00
	81	11.4	2.75	15.7	2.40	17.9	1.45	18.8	1.00
	78	15.0	2.70	18.9	2.20	20.8	1.40	21.5	1.00
	75	18.4	2.70	21.8	2.05	23.7	1.35	24.1	1.00
	72	21.5	2.65	24.7	1.90	26.5	1.35	26.6	1.00
	69	24.6	2.45	27.4	1.80	29.1	1.30	29.0	1.00
	66	27.4	2.15	30.0	1.70	31.5	1.30	31.2	1.00
	64	29.2	1.95	31.7	1.55	33.0	1.30	32.7	1.00
	63	30.1	1.85	32.6	1.50	33.7	1.25		
	60	32.6	1.60	34.8	1.35	35.8	1.25		
	57	35.0	1.40	37.0	1.20	37.8	1.15		
	54	37.4	1.05	39.1	1.05	39.7	1.00		
	51	39.2	0.75	41.1	0.75	41.3	0.75		
	49	40.4	0.60	42.3	0.55	42.4	0.55		
	48	41.0	0.55	42.9	0.50				
	47	41.6	0.45	43.4	0.45				
	46	42.2	0.40						
		45		46		48		63	
		5.6							
		120							
		1							





通常伸縮 カウンタウエイト付	ブーム 	ジブ  13.8m	アウトリガ  7.2m	作業範囲 
-------------------	--	---	--	---









 [m]	45.0							
	5		25		45		60	
	 [m]	 [ton]	 [m]	 [ton]	 [m]	 [ton]	 [m]	 [ton]
84	7.4	2.80	12.4	2.60	15.0	1.50	16.0	1.00
81	11.4	2.75	15.7	2.40	17.9	1.45	18.8	1.00
78	15.0	2.70	18.9	2.20	20.8	1.40	21.5	1.00
75	18.4	2.70	21.8	2.05	23.7	1.35	24.1	1.00
72	21.5	2.65	24.7	1.90	26.5	1.35	26.6	1.00
69	24.6	2.45	27.4	1.80	29.1	1.30	29.0	1.00
66	27.4	2.15	30.0	1.70	31.5	1.30	31.2	1.00
64	29.2	1.95	31.7	1.55	33.0	1.30	32.7	1.00
63	30.1	1.85	32.6	1.50	33.7	1.25		
60	32.6	1.60	34.8	1.35	35.8	1.25		
57	35.0	1.20	37.0	1.15	37.8	1.10		
54	36.8	0.90	39.0	0.80	39.5	0.80		
51	38.9	0.60	40.9	0.55	41.2	0.55		
49	40.2	0.40	42.0	0.40	42.3	0.40		
 危険角度 [°]	48		48		48		63	
 標準フック [ton]	5.6							
 フック質量 [kg]	120							
 巻掛本数 [本]	1							





通常伸縮 カウンタウエイト付	ブーム 	ジブ  13.8m	アウトリガ  6.5m	作業範囲 
-------------------	--	---	--	---









 [m]	45.0							
	5		25		45		60	
	 [m]	 [ton]	 [m]	 [ton]	 [m]	 [ton]	 [m]	 [ton]
84	7.4	2.80	12.4	2.60	15.0	1.50	16.0	1.00
81	11.4	2.75	15.7	2.40	17.9	1.45	18.8	1.00
78	15.0	2.70	18.9	2.20	20.8	1.40	21.5	1.00
75	18.4	2.70	21.8	2.05	23.7	1.35	24.1	1.00
72	21.5	2.65	24.7	1.90	26.5	1.35	26.6	1.00
69	24.6	2.45	27.4	1.80	29.1	1.30	29.0	1.00
66	27.4	2.05	30.0	1.70	31.5	1.30	31.2	1.00
64	29.2	1.75	31.7	1.55	33.0	1.30	32.7	1.00
63	30.1	1.55	32.6	1.45	33.7	1.25		
60	32.0	1.25	34.6	1.10	35.8	1.10		
57	34.3	0.85	36.7	0.75	37.6	0.75		
55	35.7	0.65	38.6	0.50	38.8	0.50		
54	36.4	0.50						
 危険角度 [°]	53		54		54		63	
 標準フック [ton]	5.6							
 フック質量 [kg]	120							
 巻掛本数 [本]	1							

KATO SL-850RfII 45mブーム+SLジブ (CW付) 定格総荷重表

通常伸縮 カウンタウエイト付	ブーム 	ジブ  13.8m	アウトリガ  5.4m	作業範囲 
-------------------	--	---	--	---

[m]	45.0								
	5		25		45		60		
[°]									
[°]	[m]	[ton]	[m]	[ton]	[m]	[ton]	[m]	[ton]	
84	7.4	2.80	12.4	2.60	15.0	1.50	16.0	1.00	
81	11.4	2.75	15.7	2.40	17.9	1.45	18.8	1.00	
78	15.0	2.70	18.9	2.20	20.8	1.40	21.5	1.00	
75	18.4	2.70	21.8	2.05	23.7	1.35	24.1	1.00	
72	21.5	2.60	24.7	1.90	26.5	1.35	26.6	1.00	
69	24.6	1.90	27.4	1.65	29.1	1.30	29.0	1.00	
66	26.3	1.55	29.7	1.25	31.3	1.15	31.2	1.00	
64	28.0	1.25	31.3	1.00	32.7	0.90	32.7	0.90	
63	28.9	1.05	32.0	0.85	33.4	0.75			
62	29.8	0.85							
危険 角度 標準 フック	[°]	61		62		62		63	
フック 質量	[ton]	5.6							
巻掛 本数	[kg]	120							
	[本]	1							

通常伸縮 カウンタウエイト付	ブーム 	ジブ  13.8m	アウトリガ  4.3m	作業範囲 
-------------------	--	---	--	---

[m]	45.0								
	5		25		45		60		
[°]									
[°]	[m]	[ton]	[m]	[ton]	[m]	[ton]	[m]	[ton]	
84	7.4	2.80	12.4	2.60	15.0	1.50	16.0	1.00	
81	11.4	2.75	15.7	2.40	17.9	1.45	18.8	1.00	
78	15.0	2.70	18.9	2.20	20.8	1.40	21.5	1.00	
75	18.4	2.60	21.8	2.05	23.7	1.35	24.1	1.00	
72	20.8	1.90	24.4	1.50	26.5	1.30	26.6	1.00	
70	22.5	1.50	25.9	1.25	28.3	1.05	28.2	1.00	
69	23.3	1.35	26.6	1.10					
68	24.1	1.15							
危険 角度 標準 フック	[°]	67		68		69		69	
フック 質量	[ton]	5.6							
巻掛 本数	[kg]	120							
	[本]	1							







SL-850RfII 45mブーム+SLジブ (CW付) 定格総荷重表















通常伸縮 カウンタウエイト付	ブーム 	ジブ 18.0m	アウトリガ 前方	作業範囲
-------------------	---------	-----------------	-----------------	----------





[m]	45.0								
	5		25		45		60		
	[m]	[ton]	[m]	[ton]	[m]	[ton]	[m]	[ton]	
84	8.5	1.80	14.3	1.00	18.3	0.70	20.1	0.55	
81	12.5	1.75	17.9	1.00	21.5	0.65	23.0	0.55	
78	16.3	1.50	21.3	0.95	24.5	0.60	25.7	0.55	
75	19.7	1.30	24.5	0.85	27.4	0.60	28.3	0.55	
72	22.9	1.20	27.5	0.80	30.2	0.55	30.8	0.55	
69	26.0	1.10	30.3	0.75	32.8	0.55	33.1	0.55	
66	29.0	1.00	33.0	0.70	35.2	0.55	35.4	0.55	
65	30.0	1.00	33.9	0.70	36.0	0.55	36.1	0.55	
63	32.0	0.95	35.7	0.65	37.6	0.55			
60	35.1	0.85	38.4	0.65	39.8	0.50			
57	37.7	0.80	40.5	0.60	41.9	0.50			
54	40.4	0.70	42.8	0.60	43.8	0.50			
51	43.0	0.65	45.2	0.55	45.6	0.50			
49	44.6	0.65	46.6	0.55	46.7	0.50			
48	45.4	0.60	47.3	0.55					
45	47.5	0.60	49.2	0.55					
42	49.5	0.55	50.9	0.55					
39	51.3	0.55	52.4	0.55					
36	52.9	0.50	53.6	0.50					
33	54.3	0.45	54.7	0.45					
32	54.8	0.40	55.1	0.40					
危険 角度 標準 フック	[°]	31		31		48		64	
フック 質量	[kg]	120							
巻掛 本数	[本]	1							



















SL-850RfII 45mブーム+SLジブ (CW付) 定格総荷重表













通常伸縮 カウンタウエイト付	ブーム 	ジブ  18.0m	アウトリガ  7.6m	作業範囲 
-------------------	--	---	--	---





 [m]	45.0								
	5		25		45		60		
 [°]									
	[m]	[ton]	[m]	[ton]	[m]	[ton]	[m]	[ton]	
84	8.5	1.80	14.3	1.00	18.3	0.70	20.1	0.55	
81	12.5	1.75	17.9	1.00	21.5	0.65	23.0	0.55	
78	16.3	1.50	21.3	0.95	24.5	0.60	25.7	0.55	
75	19.7	1.30	24.5	0.85	27.4	0.60	28.3	0.55	
72	22.9	1.20	27.5	0.80	30.2	0.55	30.8	0.55	
69	26.0	1.10	30.3	0.75	32.8	0.55	33.1	0.55	
66	29.0	1.00	33.0	0.70	35.2	0.55	35.4	0.55	
65	30.0	1.00	33.9	0.70	36.0	0.55	36.1	0.55	
63	32.0	0.95	35.7	0.65	37.6	0.55			
60	35.1	0.85	38.4	0.65	39.8	0.50			
57	37.7	0.80	40.5	0.60	41.9	0.50			
54	40.4	0.70	42.8	0.60	43.8	0.50			
51	43.0	0.60	45.2	0.55	45.6	0.50			
49	44.6	0.40	46.6	0.40	46.7	0.40			
 危険 角度	[°]	48		48		48		64	
 標準 フック	[ton]	5.6							
 フック 質量	[kg]	120							
 巻掛 本数	[本]	1							









通常伸縮 カウンタウエイト付	ブーム 	ジブ  18.0m	アウトリガ  7.2m	作業範囲 
-------------------	--	---	--	---





 [m]	45.0							
	5		25		45		60	
	 [m]	 [ton]	 [m]	 [ton]	 [m]	 [ton]	 [m]	 [ton]
84	8.5	1.80	14.3	1.00	18.3	0.70	20.1	0.55
81	12.5	1.75	17.9	1.00	21.5	0.65	23.0	0.55
78	16.3	1.50	21.3	0.95	24.5	0.60	25.7	0.55
75	19.7	1.30	24.5	0.85	27.4	0.60	28.3	0.55
72	22.9	1.20	27.5	0.80	30.2	0.55	30.8	0.55
69	26.0	1.10	30.3	0.75	32.8	0.55	33.1	0.55
66	29.0	1.00	33.0	0.70	35.2	0.55	35.4	0.55
65	30.0	1.00	33.9	0.70	36.0	0.55	36.1	0.55
63	32.0	0.95	35.7	0.65	37.6	0.55		
60	35.1	0.85	38.4	0.65	39.8	0.50		
57	37.7	0.80	40.5	0.60	41.9	0.50		
54	40.4	0.70	42.8	0.60	43.8	0.50		
52	42.1	0.45	44.4	0.45	45.0	0.45		
 危険角度 [°]	51		51		51		64	
 標準フック [ton]	5.6							
 フック質量 [kg]	120							
 巻掛本数 [本]	1							









通常伸縮 カウンタウエイト付	ブーム 	ジブ  18.0m	アウトリガ  6.5m	作業範囲 
-------------------	--	---	--	---

 [m]	45.0							
	5		25		45		60	
	 [m]	 [ton]	 [m]	 [ton]	 [m]	 [ton]	 [m]	 [ton]
84	8.5	1.80	14.3	1.00	18.3	0.70	20.1	0.55
81	12.5	1.75	17.9	1.00	21.5	0.65	23.0	0.55
78	16.3	1.50	21.3	0.95	24.5	0.60	25.7	0.55
75	19.7	1.30	24.5	0.85	27.4	0.60	28.3	0.55
72	22.9	1.20	27.5	0.80	30.2	0.55	30.8	0.55
69	26.0	1.10	30.3	0.75	32.8	0.55	33.1	0.55
66	29.0	1.00	33.0	0.70	35.2	0.55	35.4	0.55
65	30.0	1.00	33.9	0.70	36.0	0.55	36.1	0.55
63	32.0	0.95	35.7	0.65	37.6	0.55		
60	35.1	0.85	38.4	0.65	39.8	0.50		
57	37.7	0.65	40.5	0.60	41.9	0.50		
56	38.6	0.50	41.3	0.50	42.6	0.50		
 危険角度 [°]	55		55		55		64	
 標準フック [ton]	5.6							
 フック質量 [kg]	120							
 巻掛本数 [本]	1							

通常伸縮 カウンタウエイト付	ブーム 	ジブ  18.0m	アウトリガ  5.4m	作業範囲 
-------------------	--	---	--	---

危険角度 標準フック フック質量 巻掛本数	危険角度 [°]	45.0							
		5		25		45		60	
									
		[m]	[ton]	[m]	[ton]	[m]	[ton]	[m]	[ton]
	84	8.5	1.80	14.3	1.00	18.3	0.70	20.1	0.55
	81	12.5	1.75	17.9	1.00	21.5	0.65	23.0	0.55
	78	16.3	1.50	21.3	0.95	24.5	0.60	25.7	0.55
	75	19.7	1.30	24.5	0.85	27.4	0.60	28.3	0.55
	72	22.9	1.20	27.5	0.80	30.2	0.55	30.8	0.55
	69	26.0	1.10	30.3	0.75	32.8	0.55	33.1	0.55
	66	29.0	1.00	33.0	0.70	35.2	0.55	35.4	0.55
	65	30.0	1.00	33.9	0.70	36.0	0.55	36.1	0.55
	64	31.0	0.95	34.8	0.65	36.8	0.55		
		63		63		63		64	
		5.6							
		120							
		1							

通常伸縮 カウンタウエイト付	ブーム 	ジブ  18.0m	アウトリガ  4.3m	作業範囲 
-------------------	--	---	--	---

危険角度 標準フック フック質量 巻掛本数	危険角度 [°]	45.0							
		5		25		45		60	
									
		[m]	[ton]	[m]	[ton]	[m]	[ton]	[m]	[ton]
	84	8.5	1.80	14.3	1.00	18.3	0.70	20.1	0.55
	81	12.5	1.75	17.9	1.00	21.5	0.65	23.0	0.55
	78	16.3	1.50	21.3	0.95	24.5	0.60	25.7	0.55
	75	19.7	1.30	24.5	0.85	27.4	0.60	28.3	0.55
	72	22.9	1.20	27.5	0.80	30.2	0.55	30.8	0.55
	71	23.9	1.15	28.4	0.75	31.0	0.55	31.6	0.55
	70	25.0	1.10						
		69		70		70		70	
		5.6							
		120							
		1							